



KU LEUVEN



Glitched on Earth by Humans: A Black-Box Security Evaluation of the SpaceX Starlink User Terminal

Lennert Wouters

@LennertWo

Starlink 101

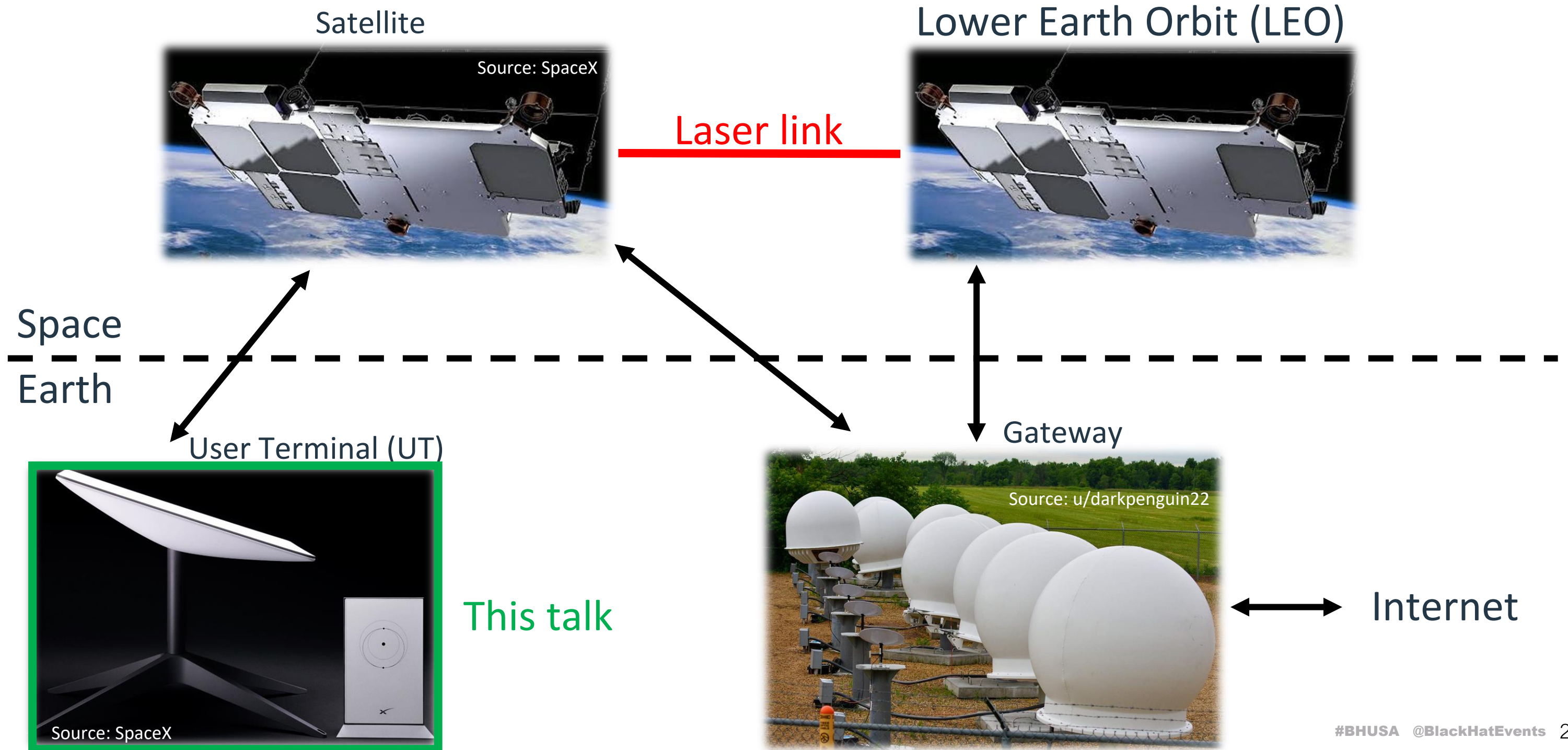



Teardowns



MikeOnSpace
18.9K subscribers

NOVA SCOTIA
Starlink Dish TEARDOWN! - Part 1 - SpaceX BugBounty is open
68,078 views • Nov 22, 2020

youtube.com/c/MikeOnSpace @mikeonspace

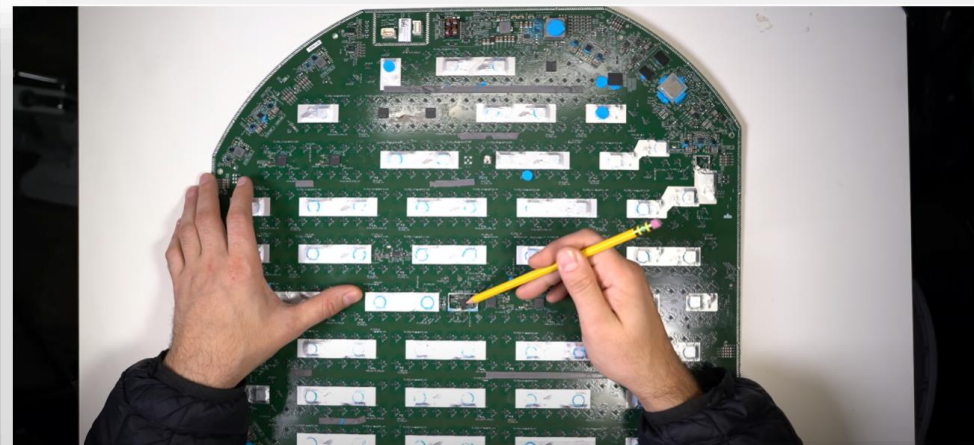

Ken Keiter
4.8K subscribers

WASHINGTON
Starlink Teardown: DISHY DESTROYED!
391,294 views • Nov 25, 2020

youtube.com/c/KenKeiter @kenkeiter



The Signal Path
102K subscribers

TSP #181 - Starlink Dish Phased Array Design, Architecture
102,965 views • Jan 11, 2021

youtube.com/c/TheSignalPath @TheSignalPath



Colin O'Flynn
10.5K subscribers

NOVA SCOTIA
Starlink Dishy (Rev2 HW) Teardown Part 1 - UART, Re
7,514 views • Jul 5, 2021

youtube.com/c/ColinOFlynn @colinoflynn

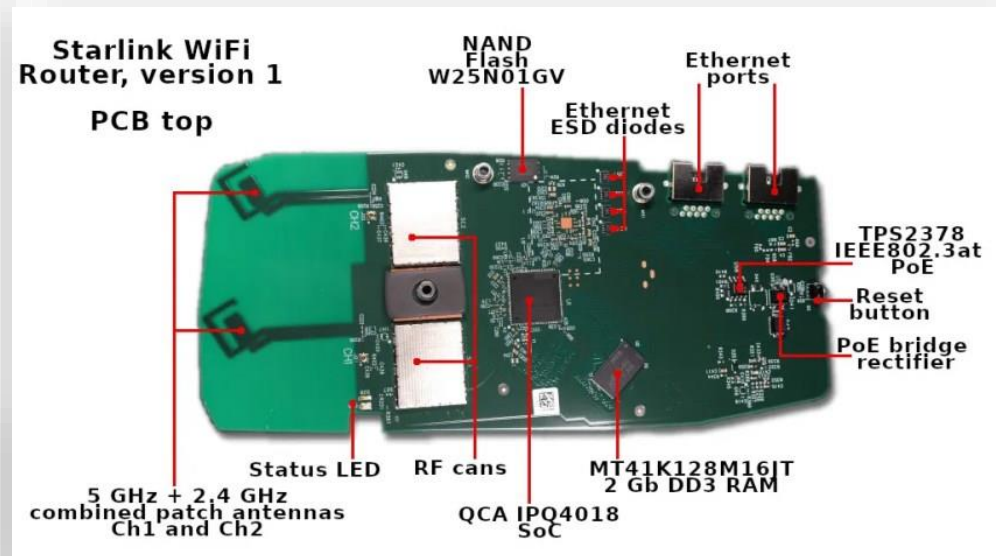

olegkutkov.me @olegkutkov

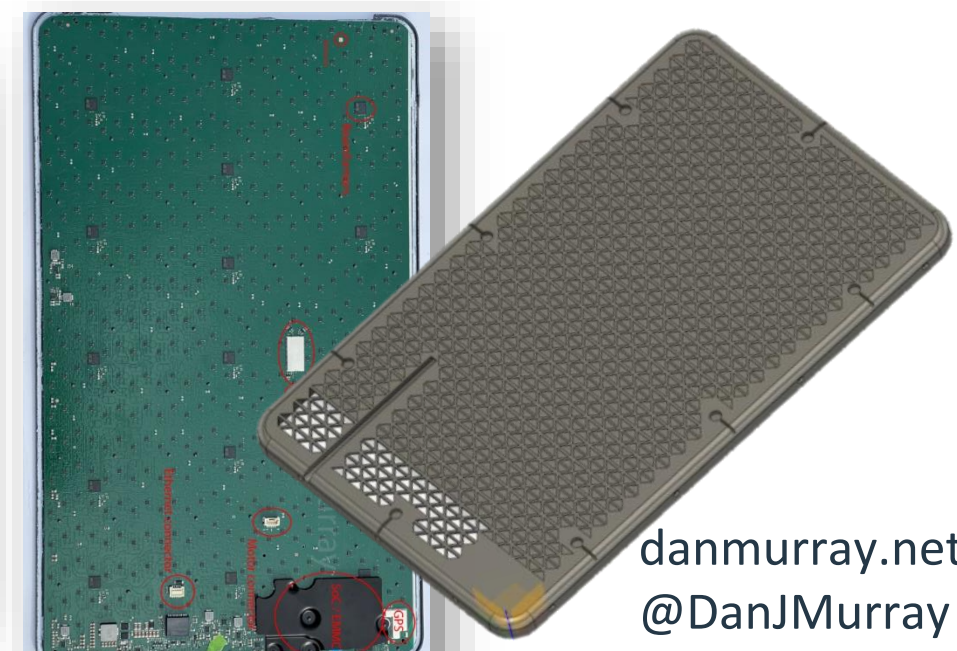

Hardware revisions

Circular UT

- 59 cm (23,23") diameter
- Residential
- rev1_pre_production
- rev1_production
- rev1_proto1/2/3
- rev2_proto0/1/3
- rev2_proto2 (SoC cut 3)
- rev2_proto4 (SoC cut 4)

Square UT

- 50 x 30 cm (19" x 12")
- Residential and RV
- rev3_proto0
- rev3_proto1
- rev3_proto2

High Performance UT

- 57 x 51 cm (22" x 20")
- Business and Maritime
- hp1_proto0
- hp1_proto1

Transceiver

- External phased array
- transceiver_rev2p0/5

This talk (but attack should apply to all UT hardware)

Accessible connectors on V2*

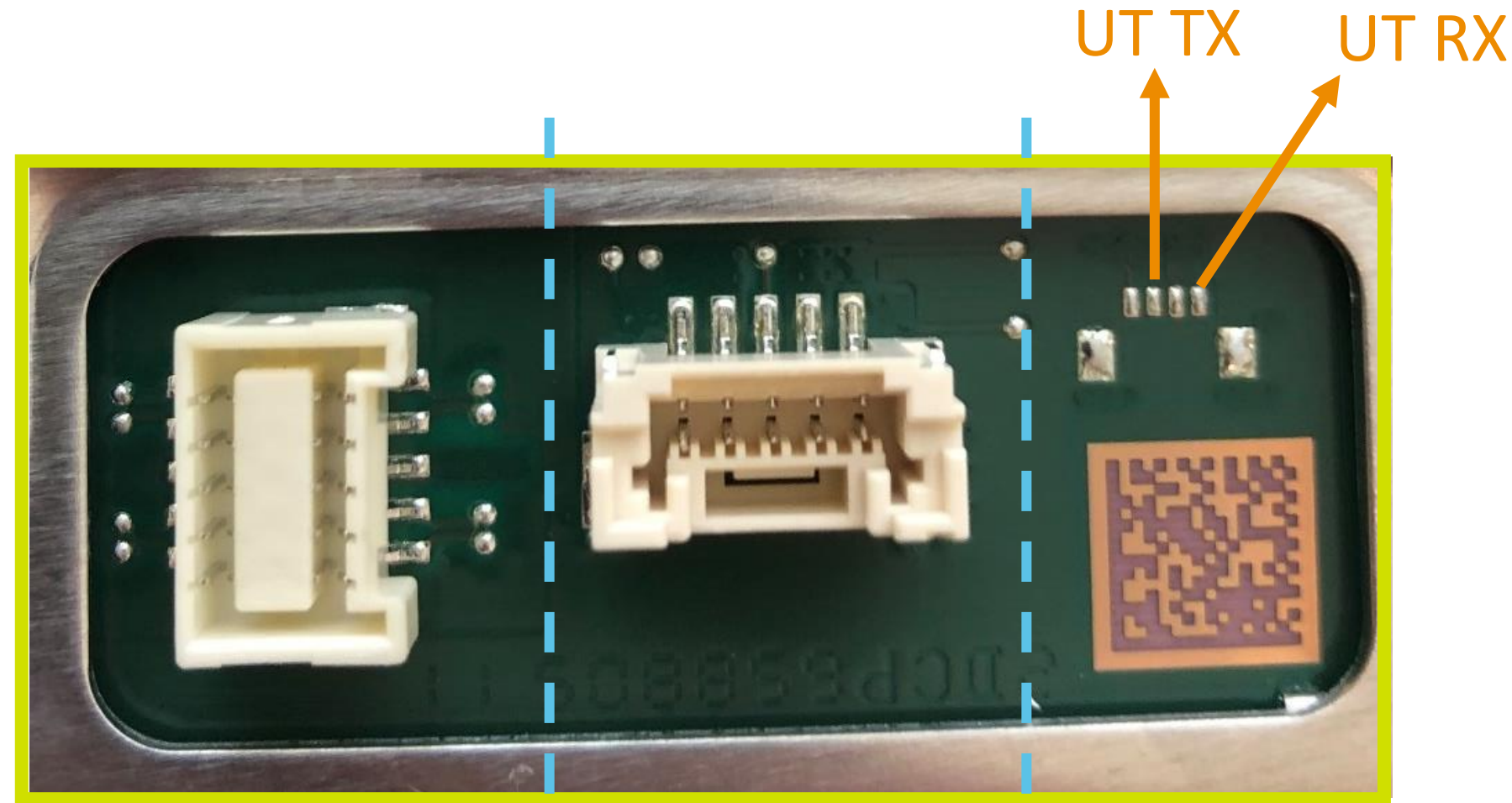
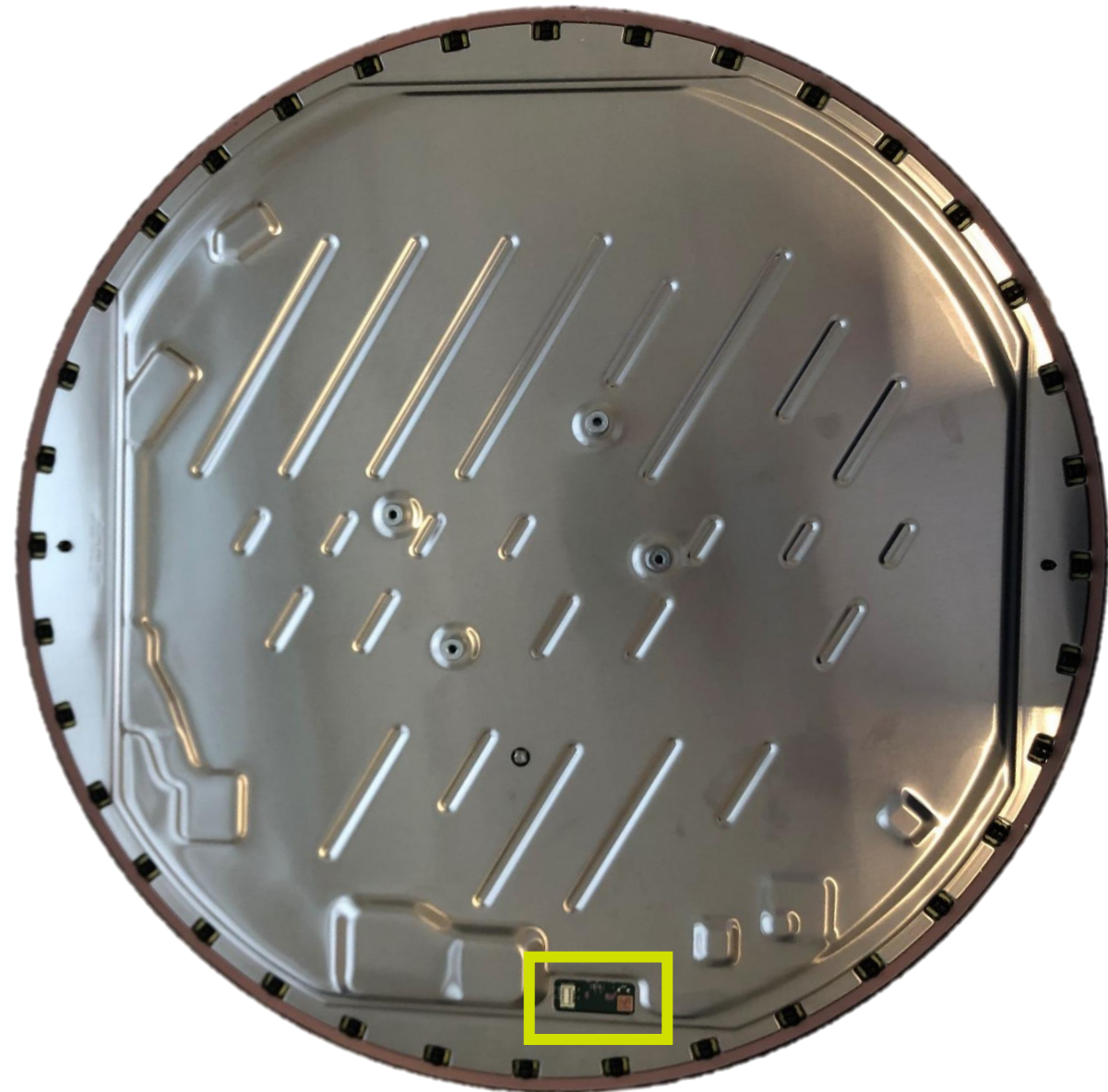

ethernet + power

JST BM10B-ZPDSS-TF(LF)(SN)

motors

JST BM05B-ZESS-TBT(LF)(SN)

UART

*V1 hardware had an extra connector, V3 does not have easily accessible connectors

UART – Login Prompt

```
Development login enabled: no
```

```
SpaceX User Terminal.
```

```
user1 login:
```

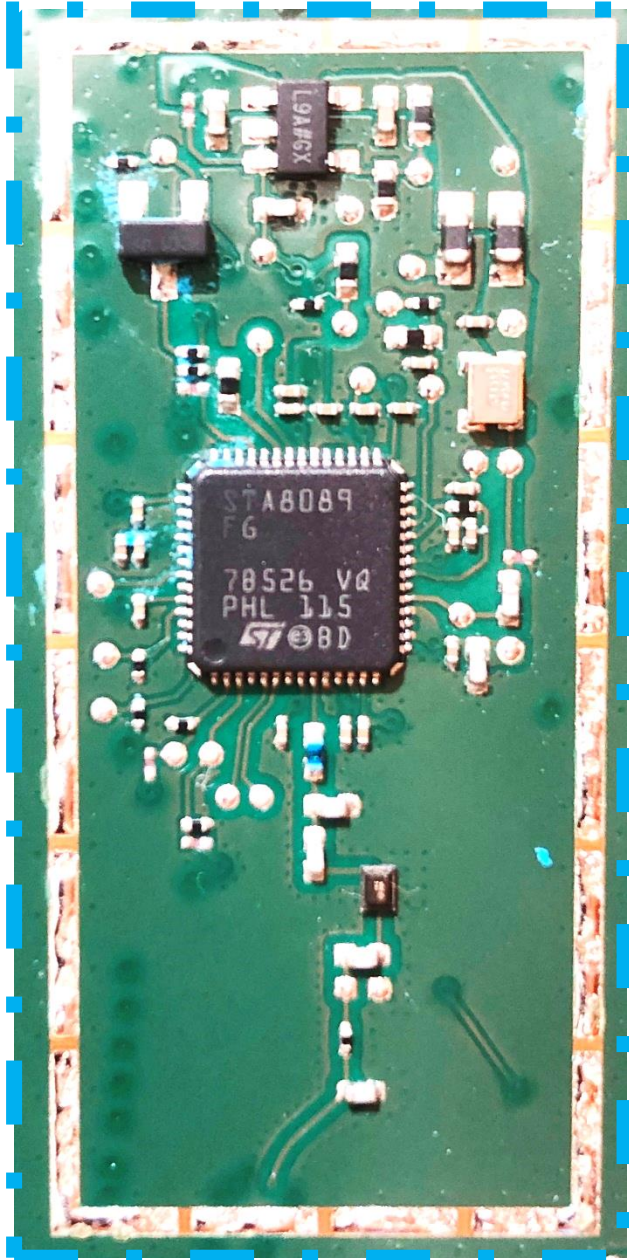

PCB overview

GPS receiver

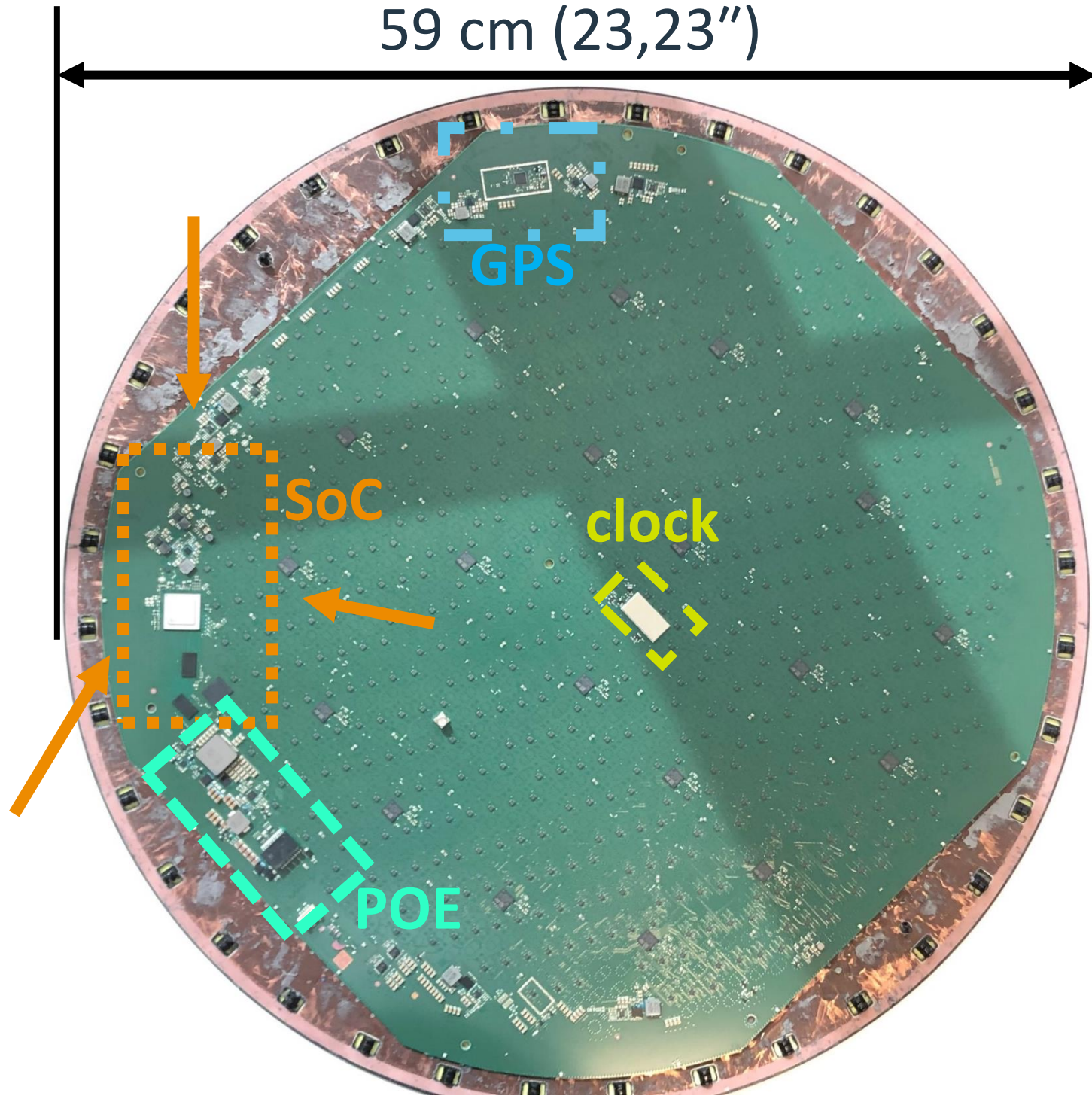

STM STA8089

59 cm (23,23")



Clock generation

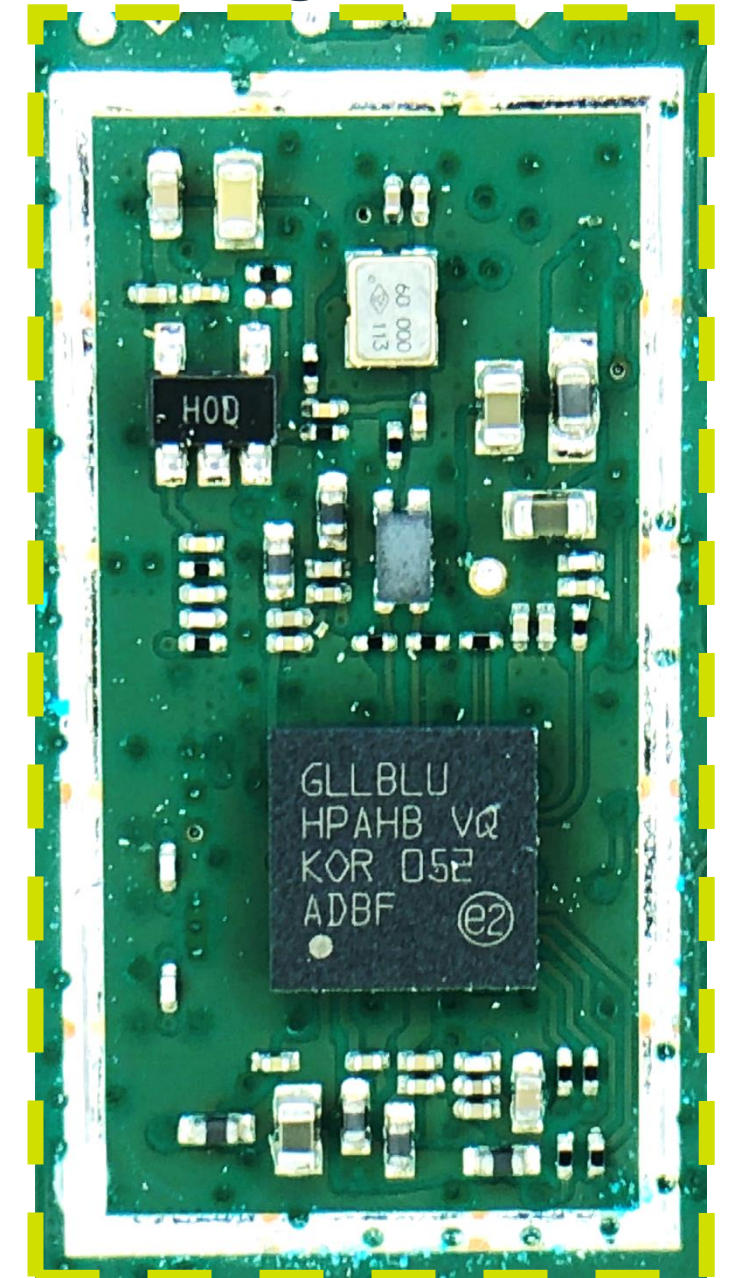

GLLBLU

RF Components

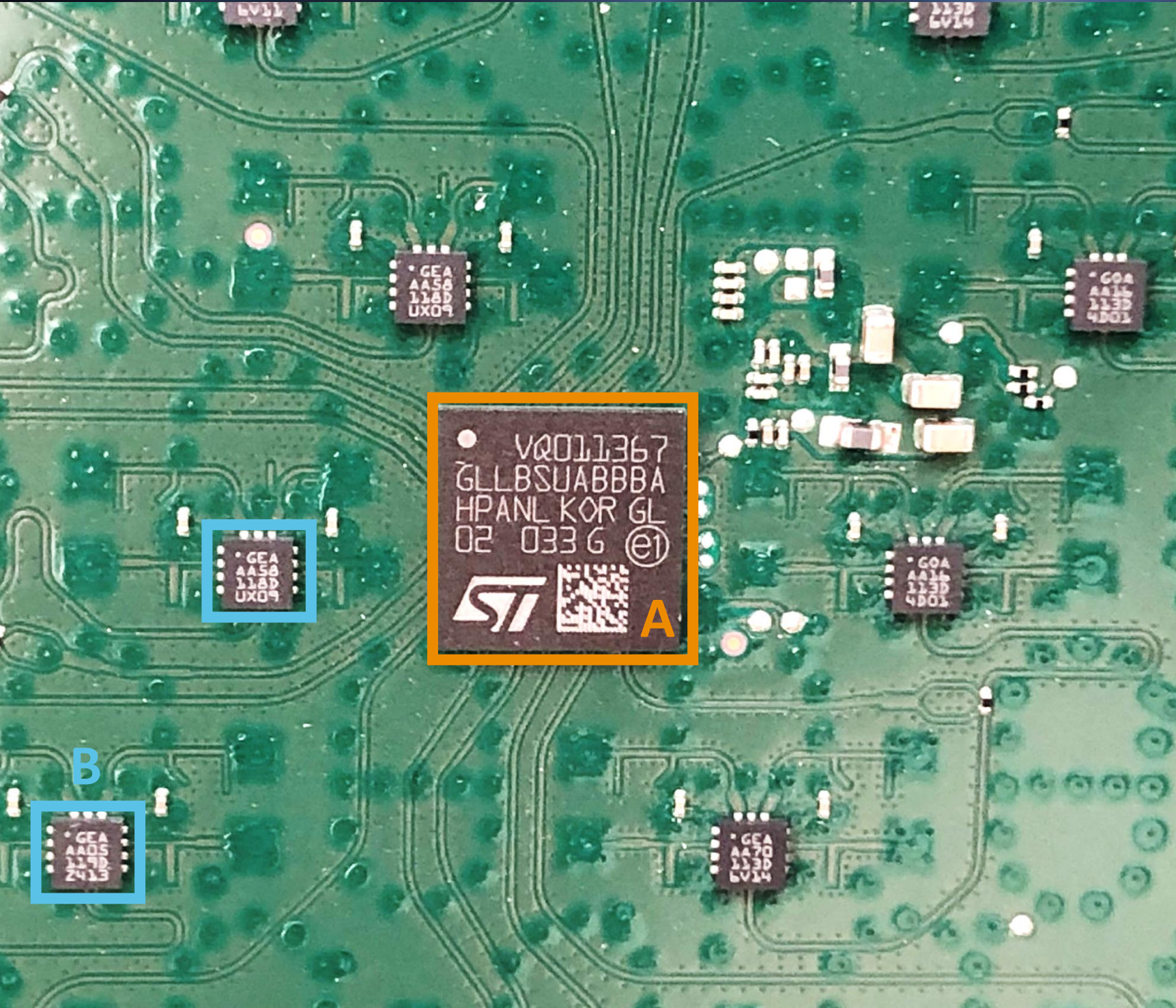

- (A) Digital BeamFormer (DBF)
 - STM GLLBSUABBBA
 - Codename: **SHIRAZ**
- (B) Front-End Module (FEM)
 - Codename: **PULSAR(AD)**
- V2 hardware and up:
 - 1 DBF → 16 FEMs

SHIRAZ

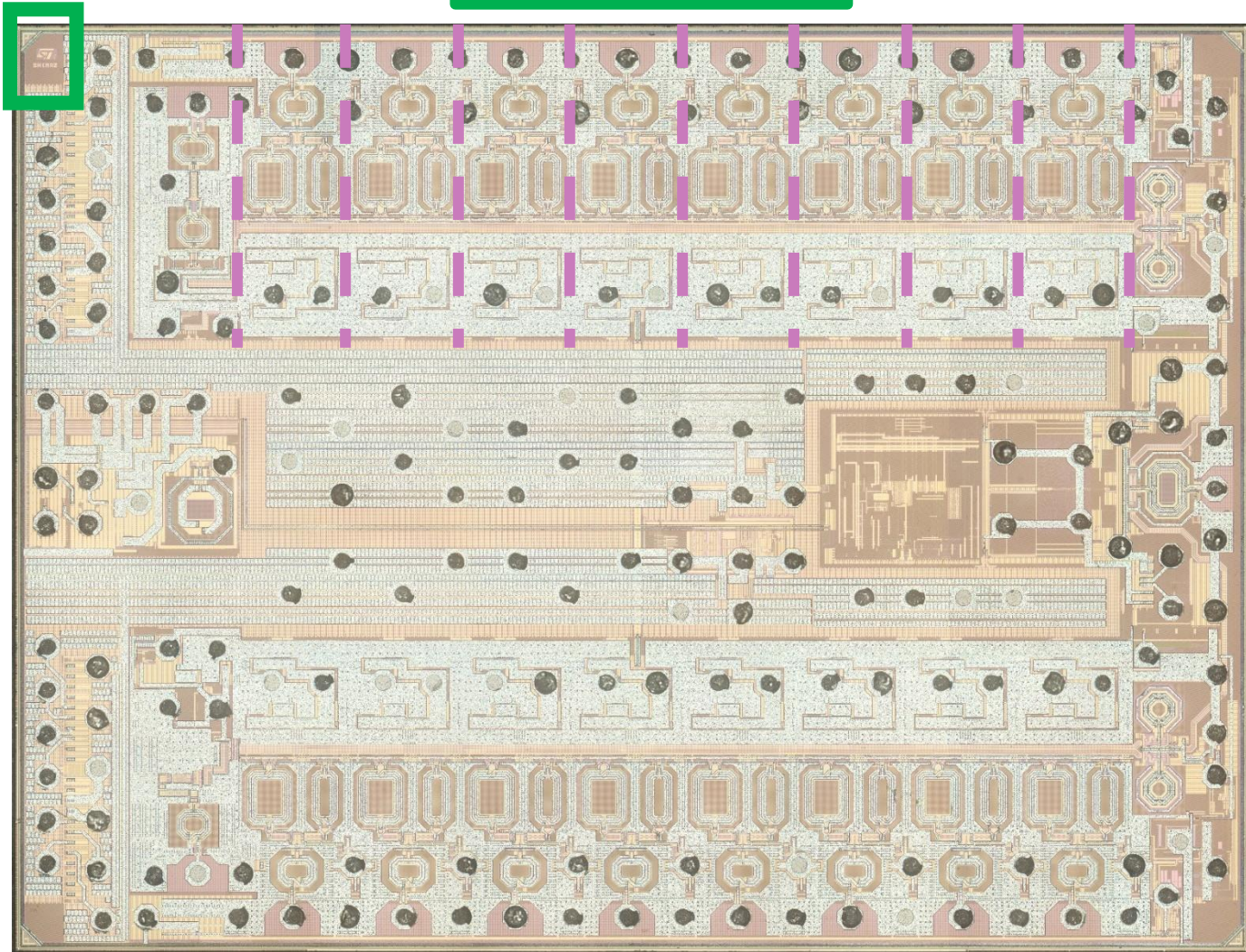

siliconpr0n.org/archive/doku.php?id=mcmaster:spacex:gllbsuabbba-shiraz

PULSARAD

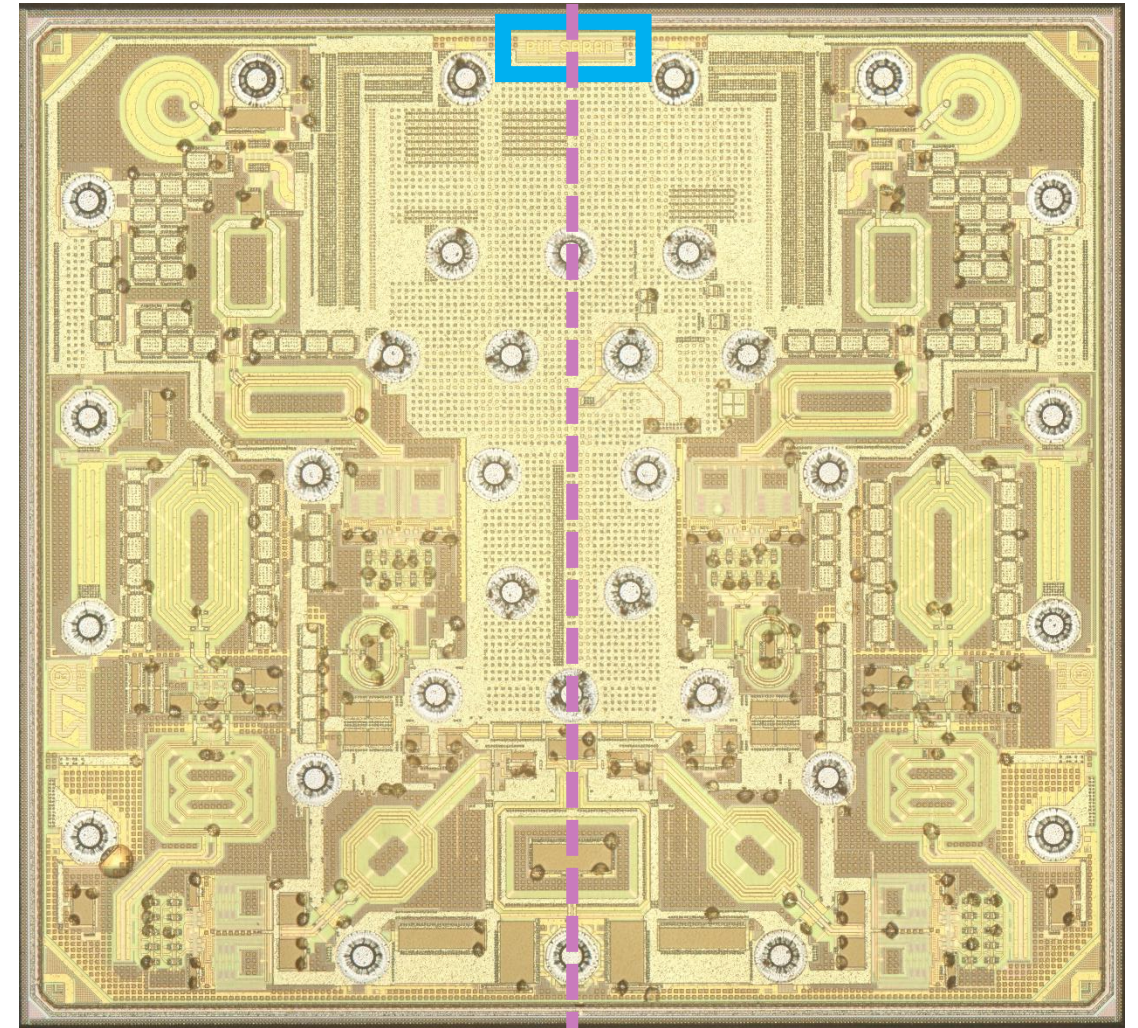

[id=mcmaster:spacex:gea-aa12-109d-tg02-pulsarad](https://siliconpr0n.org/archive/doku.php?id=mcmaster:spacex:gea-aa12-109d-tg02-pulsarad)

Thanks to John McMaster!

@johndmcmaster

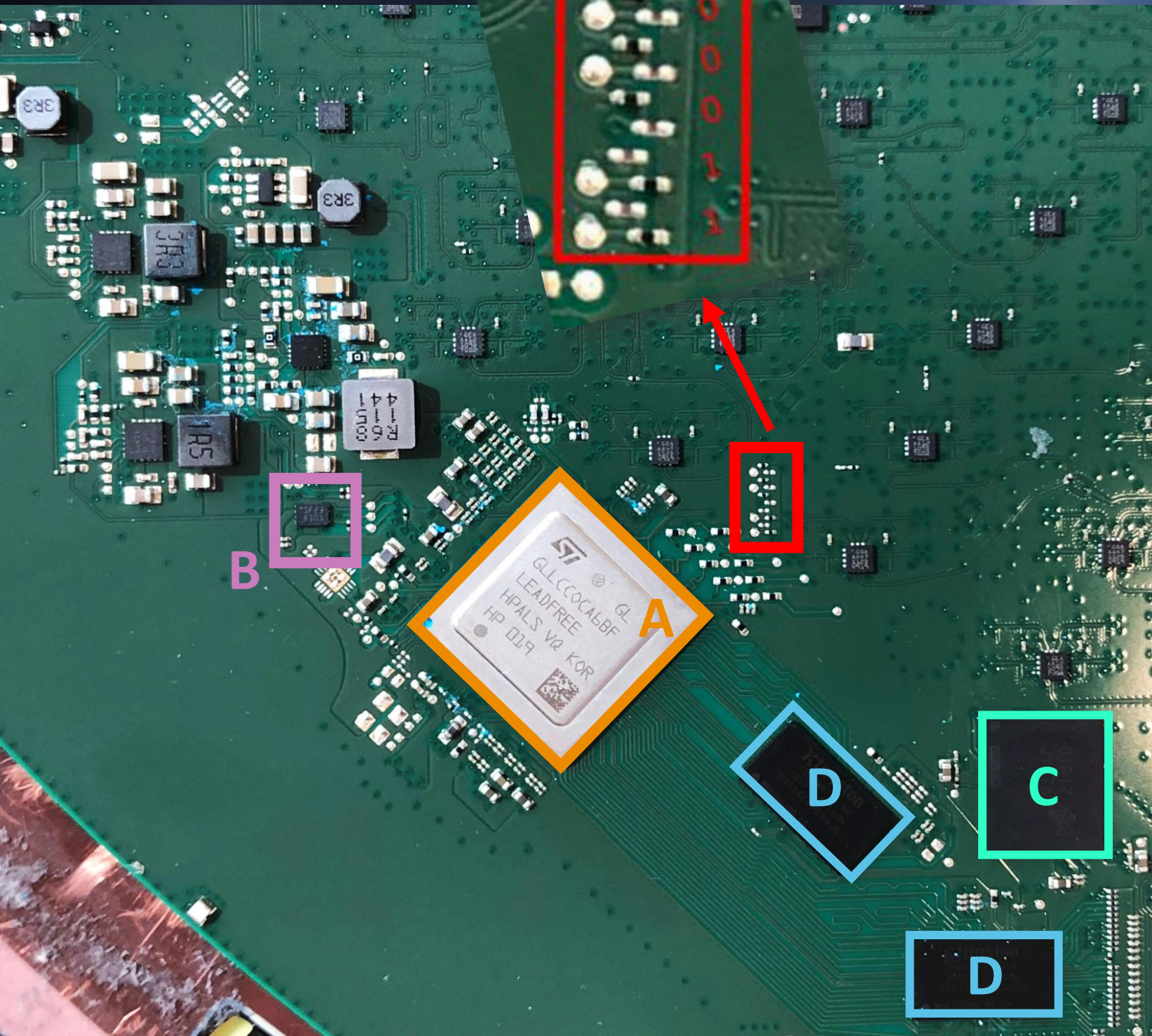

- (A) System-on-Chip
 - Custom quad-core ARM Cortex-A53
 - ST Microelectronics
 - GLLCCOCA6BF (cut 3?)
 - GLLCCODA6BF (cut 4?)
 - Codename: **CATSON**
- (B) Secure Element
 - STM STSAFE-A110
- (C) 4GB eMMC
- (D) 2 x 4Gbit DDR3

- through substrate image
 - GLLCCOCA6BF (cut 3?)
 - Thorlabs NIR camera
 - Mitutoyo NIR objective 50x
- Can help narrow down interesting locations for some physical attacks
- Full resolution version will be available on siliconpr0n.org!

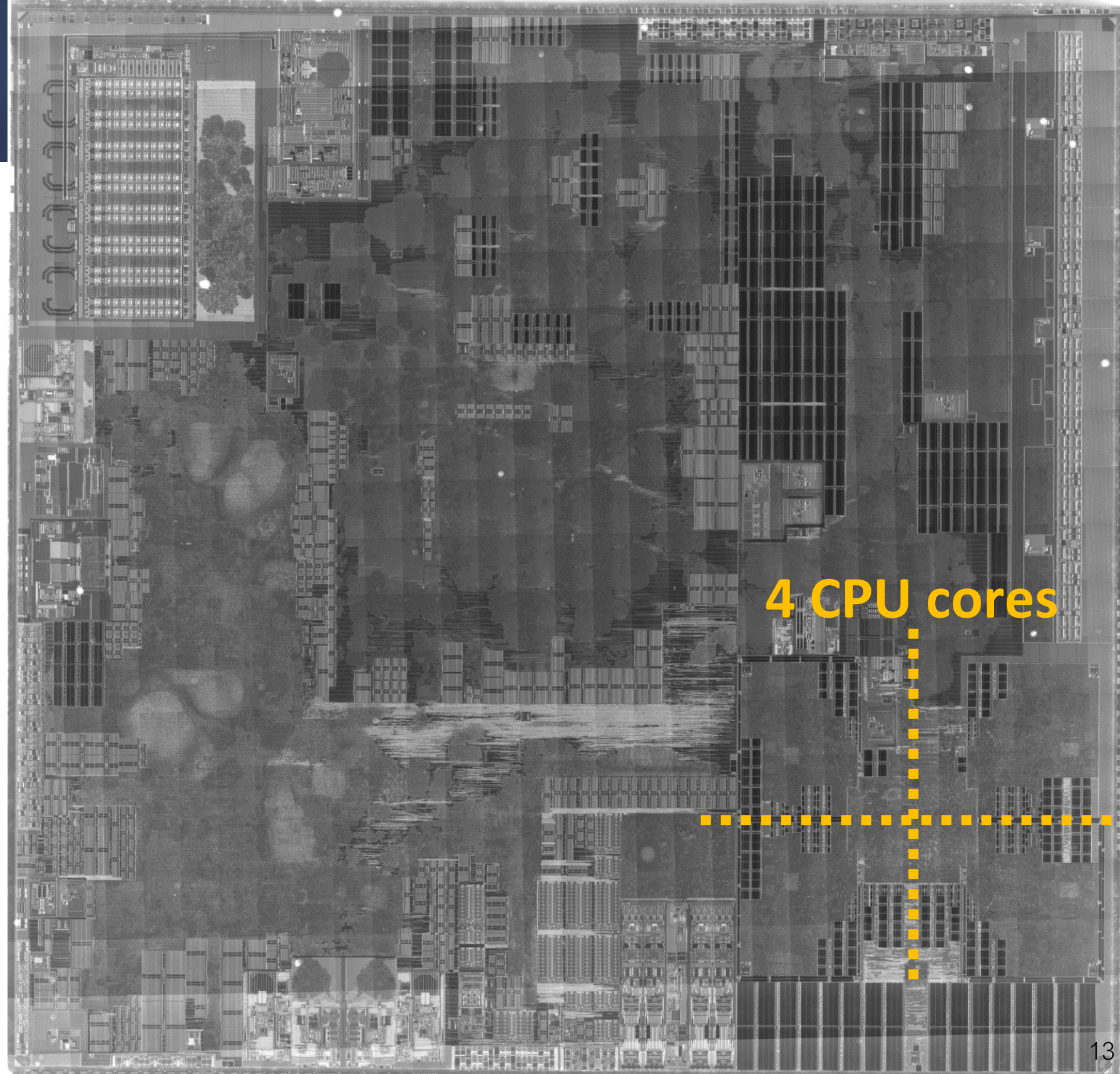

Identifying eMMC test points

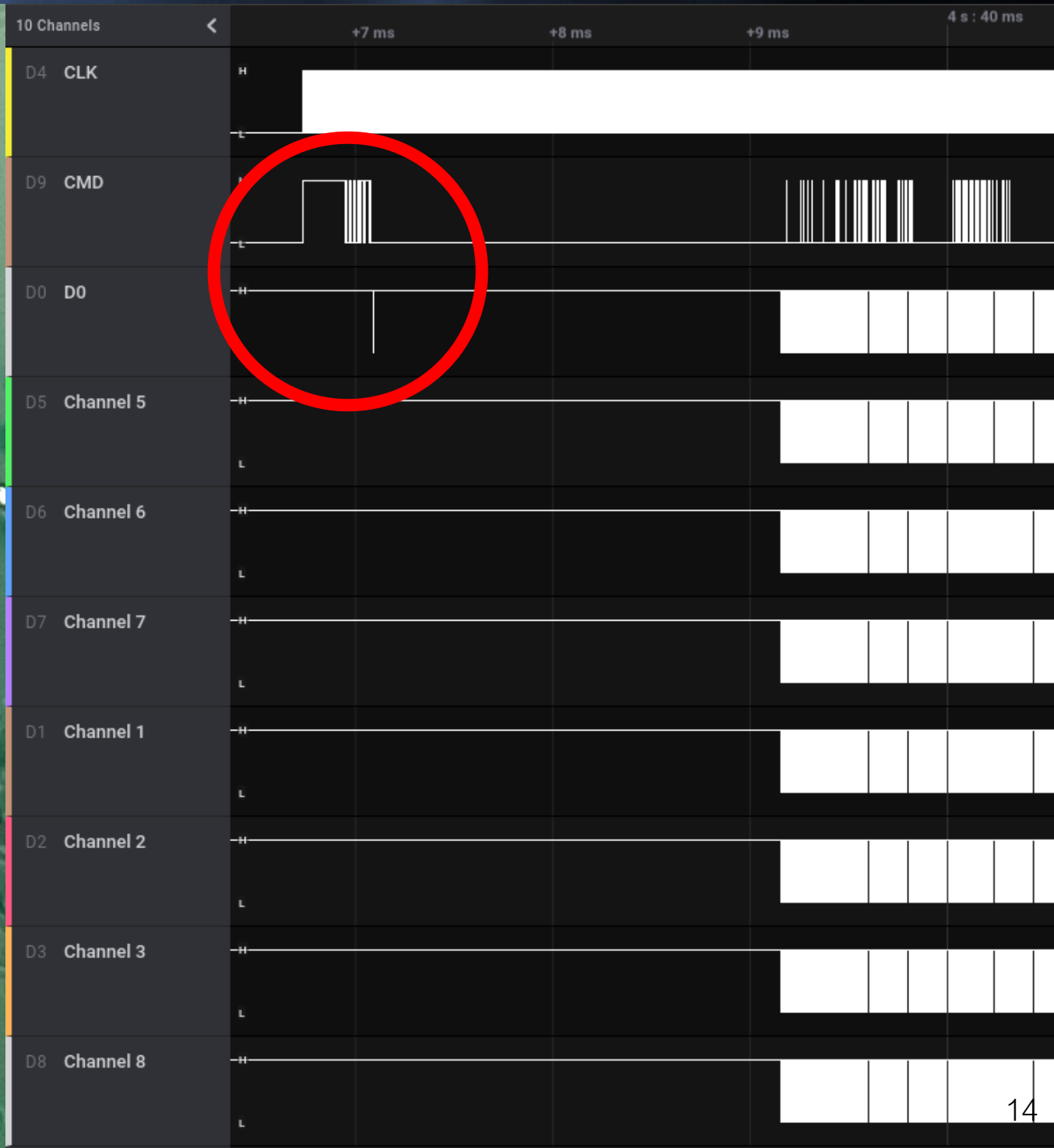
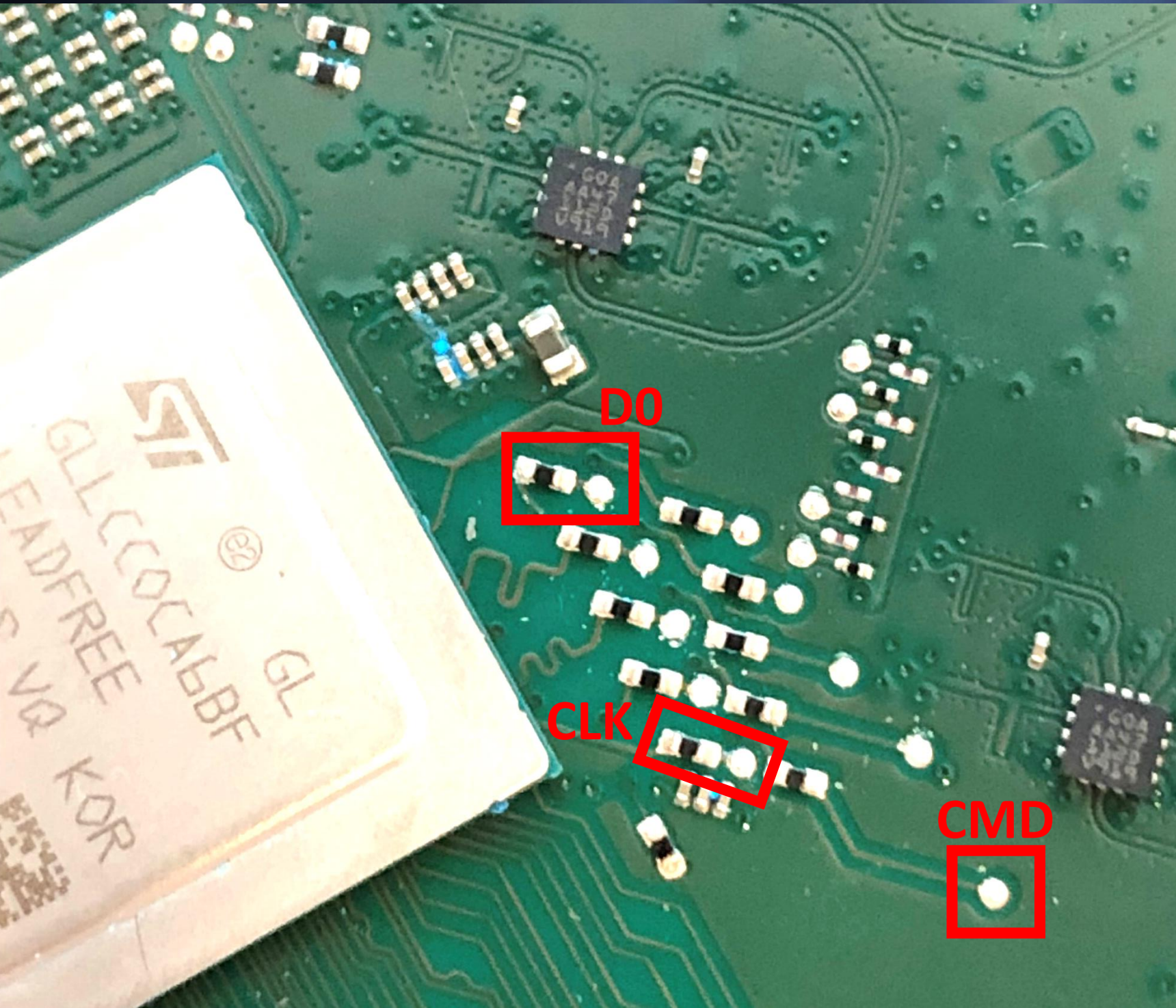

Reading eMMC in-circuit

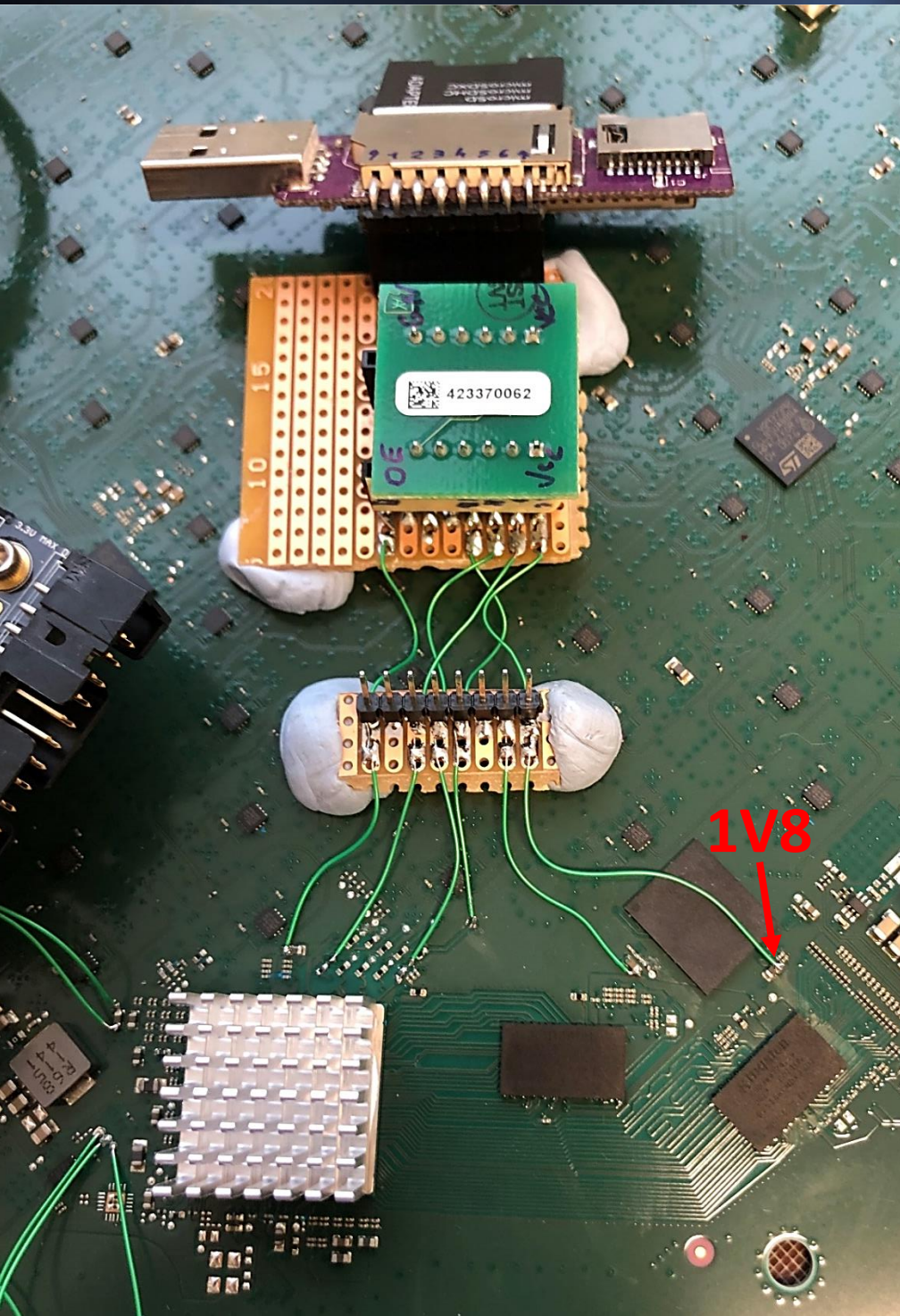

SD card reader

TXS0202EVM
Level shifter

← What I did

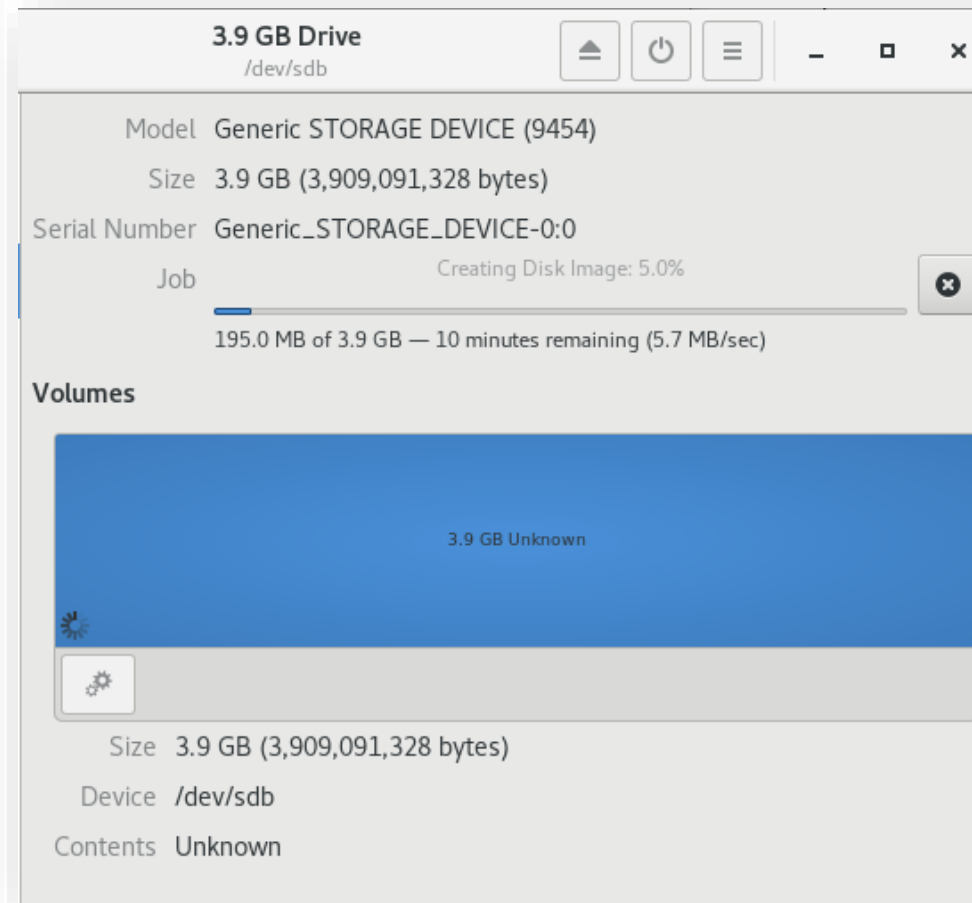

What I recommend →

Low Voltage eMMC Adapter
by
eXploitee.rs

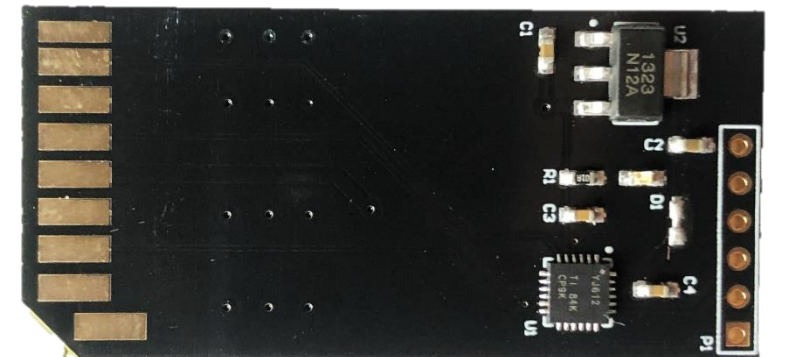

Extracting the eMMC dump

- Split the dump into:
 - TF-A Bootstages: Firmware Image Packages
 - unpack with TF-A fiptool
 - Flattened ulmage Tree (FIT)
 - unpack with U-Boot dumpimage
 - SpaceX Runtime (dm-verity, error correcting codes)
 - SpaceX Calibration (dm-verity)
 - SpaceX EDR (LUKS)
 - SpaceX dish config (LUKS)

```
#define CATS_BOOTFIP_0_OFFSET 0x00000000
#define CATS_BOOTFIP_1_OFFSET 0x100000
#define CATS_BOOTFIP_2_OFFSET 0x200000
#define CATS_BOOTFIP_3_OFFSET 0x300000
#define CATS_BOOTTERM1_OFFSET 0x400000
#define CATS_BOOTMASK1_OFFSET 0x480000
#define CATS_BOOTTERM2_OFFSET 0x500000
#define CATS_BOOTMASK2_OFFSET 0x580000
#define CATS_BOOT_A_0_OFFSET 0x600000
#define CATS_BOOT_B_0_OFFSET 0x700000
#define CATS_BOOT_A_1_OFFSET 0x800000
#define CATS_BOOT_B_1_OFFSET 0x900000
#define CATS_UBOOT_TERM1_OFFSET 0xA00000
#define CATS_UBOOT_TERM2_OFFSET 0xB00000
#define CATS_UNUSED_OFFSET 0xC00000
#define CATS_MTD00PS_OFFSET 0xF00000
#define CATS_VERSION_INFO_A_OFFSET 0xF30000
#define CATS_VERSION_INFO_B_OFFSET 0xF50000
#define CATS_SECRETS_A_OFFSET 0xF70000
#define CATS_SECRETS_B_OFFSET 0xF90000
#define CATS_SXID_OFFSET 0xFB0000
#define CATS_KERNEL_A_OFFSET 0x1000000
#define CATS_CONFIG_A_OFFSET 0x2800000
#define CATS_KERNEL_B_OFFSET 0x3000000
#define CATS_CONFIG_B_OFFSET 0x4800000
#define CATS_SX_A_OFFSET 0x5000000
#define CATS_SX_B_OFFSET 0x6800000
#define CATS_EDR_OFFSET 0x8000000
#define CATS_DISH_CONFIG_OFFSET 0x113D1C00
```

U-Boot GPL sources: spacex_catson_boot.h

- More details:
 - esat.kuleuven.be/cosic/blog/dumping-and-extracting-the-spacex-starlink-user-terminal-firmware

Temperature and RF channels

```
1 # This file describes the limits for thermal control.
2 # All temperatures are in degrees Celsius.
3 # All control cycle counts are for 50 Hz.
4
5 # ----- Power-cut -----
6
7 # When any sensor exceeds these trip thresholds for its corresponding
8 # persistence, the power to all DBFs and FEMs will be cut. The User Terminal
9 # must reboot to recover. These temperatures are slightly above the maximum
10 # junction temperature of the corresponding components. MAC throttle and forced
11 # idle is intended to more-gracefully take care of all overtemp situations.
12 # This FDIR is a last-ditch response to reduce in case idling is insufficient
13 # or we have lost control of the beamformers.
14
15 center_power_cut.t_trip 90.0
16 cpu0_power_cut.t_trip 128.0
17 pa_power_cut.t_trip 118.0
18 dbf_power_cut.t_trip 118.0
19
20
21 # The number of cycles that the trip thresholds must be exceeded for before
22 # the power-cut FDIR activates.
23
24 center_power_cut_persistence_limit 2000 # 40 seconds
25 cpu0_power_cut_persistence_limit 2000 # 40 seconds
26 pa_power_cut_persistence_limit 2000 # 40 seconds
27 dbf_power_cut_persistence_limit 2000 # 40 seconds
28
29 # The number of cycles from when power-cut is tripped to when the UT reboots.
30 # Gives time to allow the UT to cool down.
31
32 power_cut_reboot_delay 30000 # 10 minutes
33
34
35 # ----- Forced-idle -----
36
37 # When any sensor exceeds these trip thresholds for its corresponding
38 # persistence, all DBFs and FEMs will be commanded to Idle mode.
39 # Once all sensors have fallen below their clear thresholds, normal
```

```
    "channel_id": 13,
    "direction": "uplink"
    "end": 14.1875,
    "start": 14.125
  },
  {
    "channel_id": 14,
    "direction": "uplink"
    "end": 14.25,
    "start": 14.1875
  }
}
```

```
"laser_channel_definitions": [
  {
    "color": "LASER_COLOR_RED",
    "frequency_ghz": 192700,
    "itu_channel_id": 27
  },
  {
    "color": "LASER_COLOR_BLUE",
    "frequency_ghz": 193500,
    "itu_channel_id": 35
  }
],
```

Development geofences

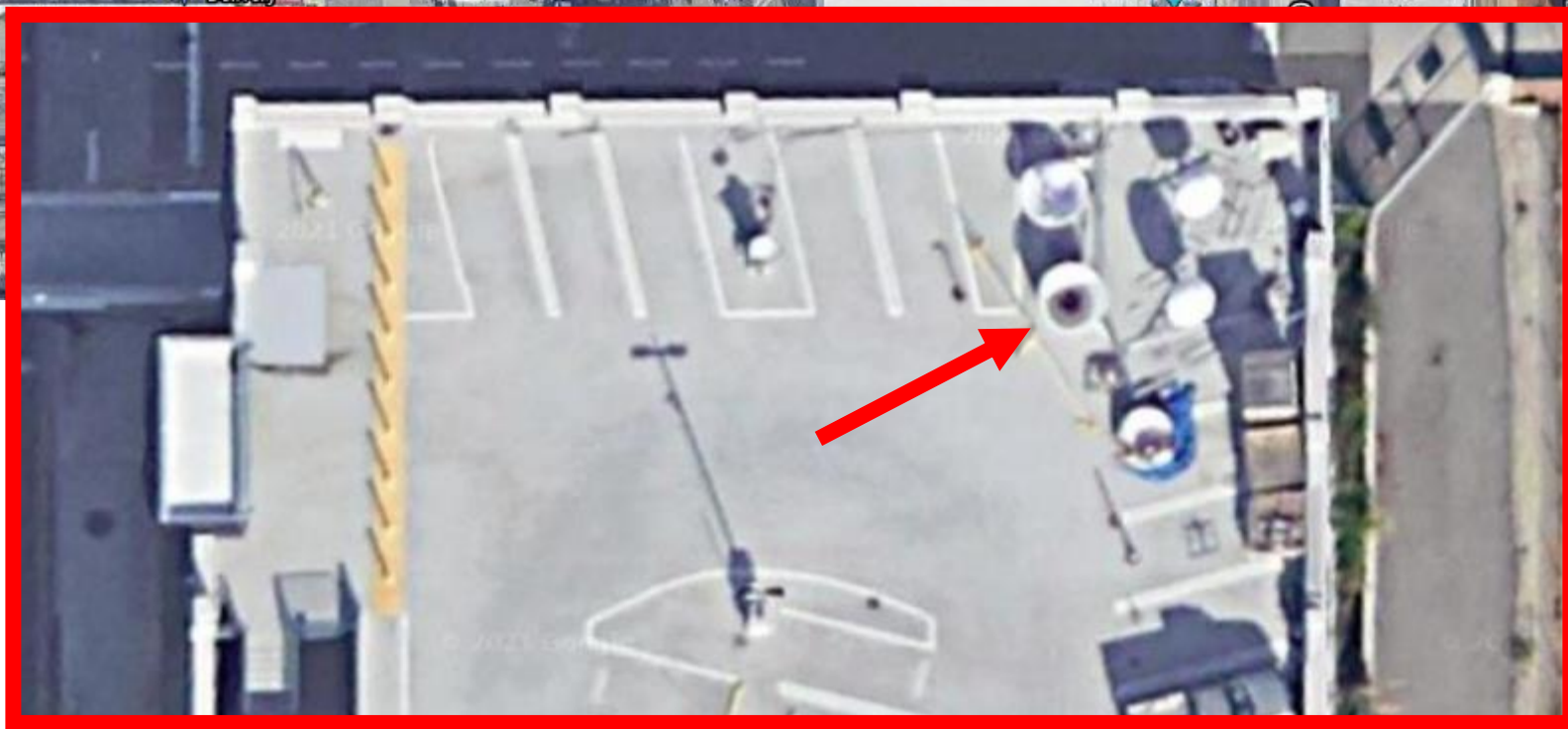

Obtaining root

Development login enabled: no

SpaceX User Terminal.

user1 login:

```
echo -n "Development login enabled: "  
if [ $(is_production_hardware) -eq 0 ]; then  
    echo "yes"  
    sed -i -e 's/^\(root:[^:]*\)\/root:tSXNnW65X1Er.\/' /etc/shadow 2>/dev/null || true  
else  
    echo "no"  
    if [[ $(whatVehicleAmI) = "uterm" ]]; then  
        # Discard console output for production user terminals.  
        consoletype=ttynull  
    fi  
fi
```



Fault injection

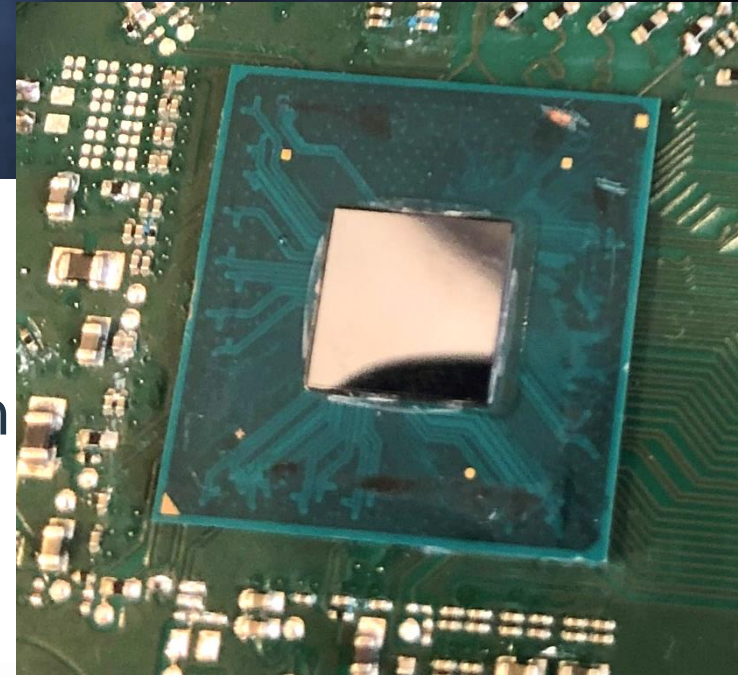

- ✓ Flip-chip packaging exposes die backside
 - Laser Fault Injection, Body Bias Injection, Electromagnetic Fault Injection
- x PCB is too big for our automatic XYZ positioning equipment
 - Likely cumbersome to do on a roof...

x No development kits

- Differential clock input
 - (But PLL?)
- Reset line
- Voltage Fault Injection

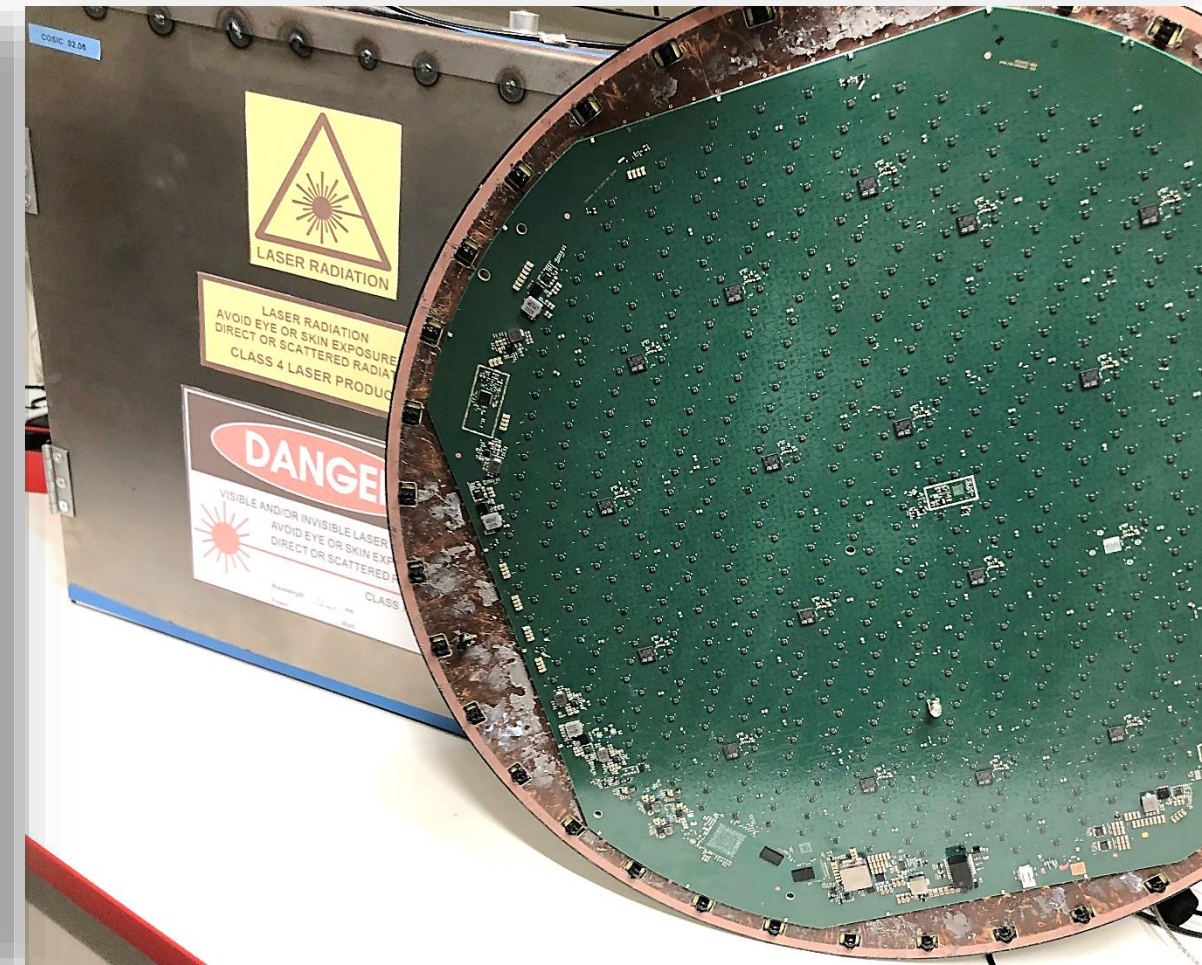
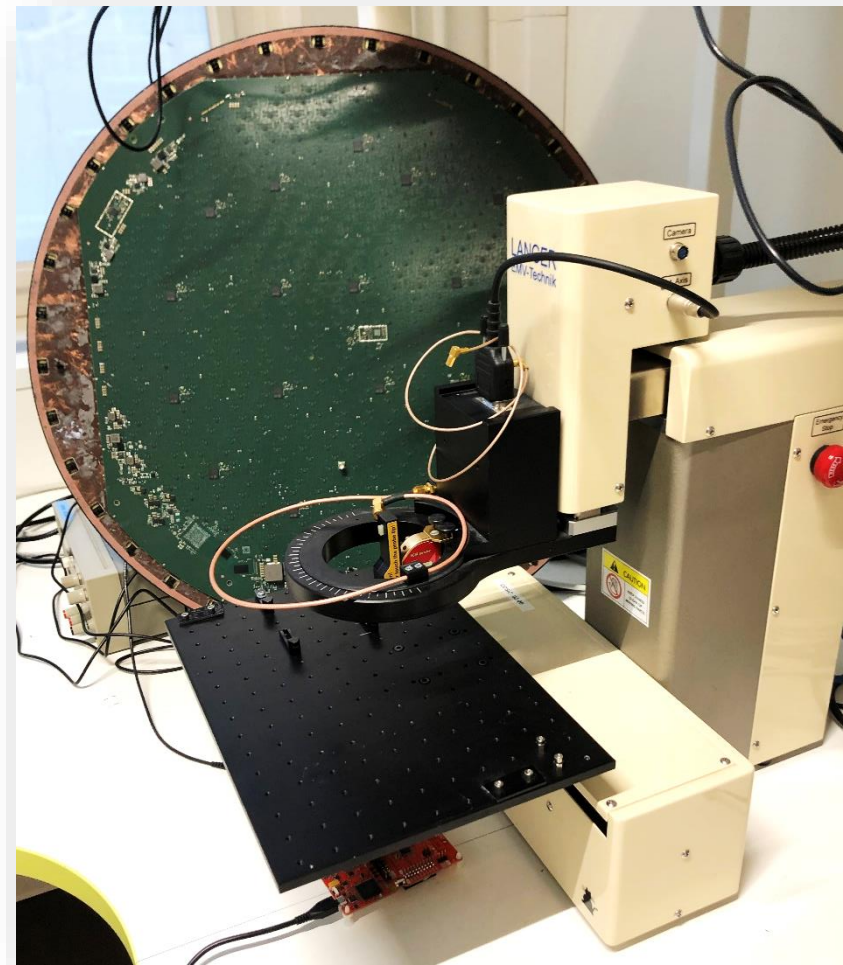

- NewAE ChipWhisperer-Lite (~ \$250)
 - Glitch port is connected to the SoC core voltage
 - Momentarily shorts core voltage to GND
- Core voltage: ~1V, generated by TI TPS56C230
- All decoupling capacitors untouched at this point!
- Oscilloscope triggers on serial data
 - Trigger output is input to the ChipWhisperer-Lite
- Glitch parameters controlled from Python
 - Offset from trigger point
 - Glitch width

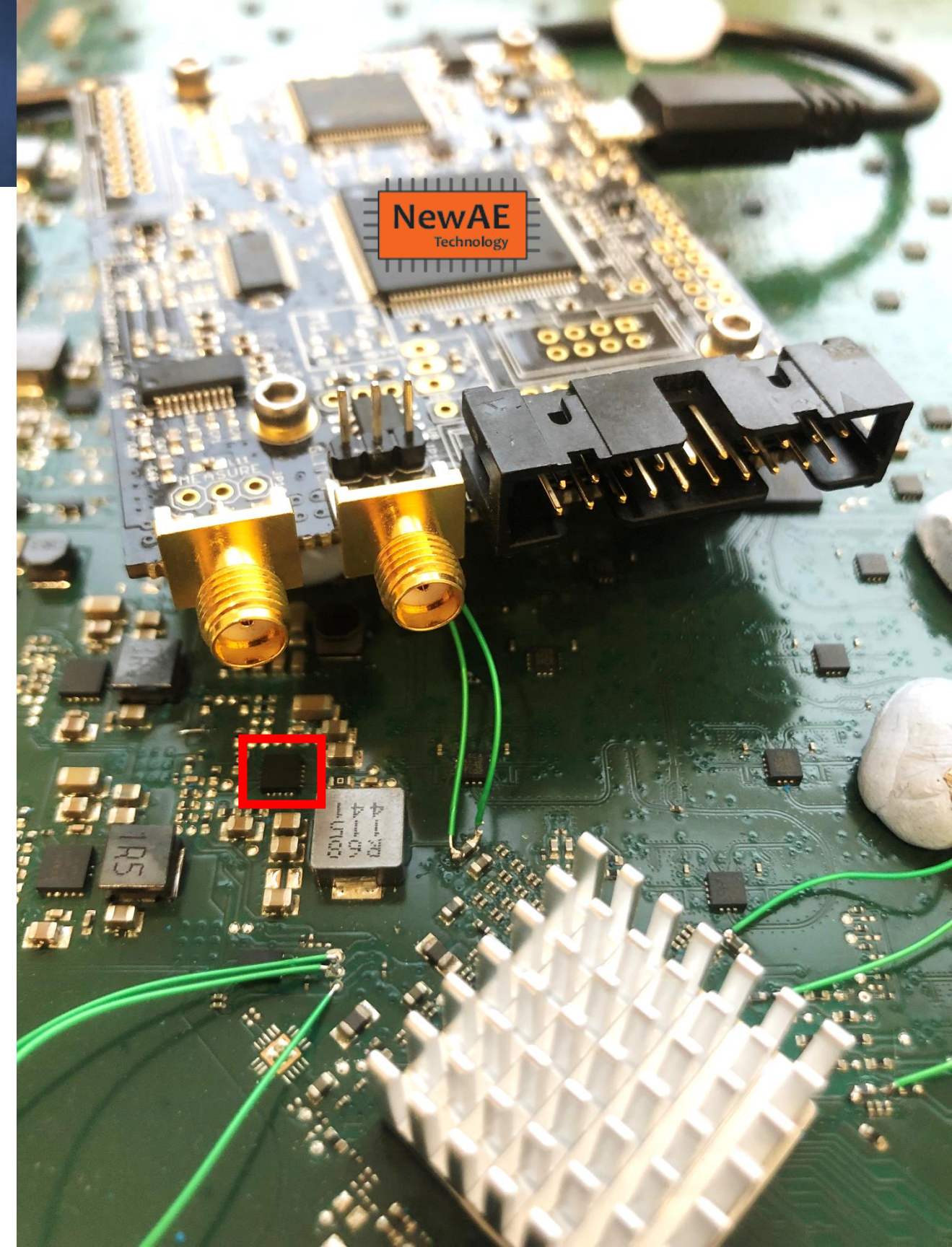

Example output

```
Development login enabled: [ 7.387682] 002: Unable to handle kernel NULL pointer dereference at virtual address 0000000000000820
[ 7.387702] 002: Mem abort info:
sh: 0: unknown operand
[ 7.387704] 002: ESR = 0x96000006
yes
[ 7.387707] 002: EC = 0x25: DABT (current EL), IL = 32 bits
[ 7.387711] 002: SET = 0, FnV = 0
[ 7.387714] 002: EA = 0, S1PTW = 0
[ 7.387716] 002: Data abort info:
[ 7.387718] 002: ISV = 0, ISS = 0x00000006
[ 7.387721] 002: CM = 0, WnR = 0
[ 7.387723] 002: user pgtable: 4k pages, 39-bit VAs, pgdp=00000000a51fd000
[ 7.387730] 002: [0000000000000820] pgd=00000000a50d1003, pud=00000000a50d1003, pmd=0000000000000000
[ 7.387739] 002: Internal error: Oops: 96000006 [#1] PREEMPT_RT SMP
[ 7.387748] 002: Modules linked in:
[ 7.387753] 002: CPU: 2 PID: 275 Comm: syslogd Not tainted 5.4.34-rt21-gfd24730 #1
[ 7.387760] 002: Hardware name: spacex_satellite_user_terminal (DT)
[ 7.387766] 002: pstate: 00000005 (nzcw daif -PAN -UA0)
[ 7.387770] 002: pc : do_undefinstr+0x2c/0x1d8
[ 7.387787] 002: lr : el0_undef+0xc/0x10
[ 7.387793] 002: sp : ffffffff0145b3e70
[ 7.387797] 002: x29: ffffffff0145b3e70 x28: ffffffff8025009a00
[ 7.387803] 002: x27: 0000000000000000 x26: 0000000000000000
[ 7.387808] 002: x25: 0000000002000000 x24: 0000000000000000
[ 7.387814] 002: x23: 0000000080000000 x22: 0000000000403fb0
[ 7.387818] 002: x21: 00000000ffffffff x20: 0000000000000000
[ 7.387823] 002: x19: 0000000000000018 x18: 0000000000000000
[ 7.387828] 002: x17: 0000000000000000 x16: 0000000000000000
[ 7.387832] 002: x15: 0000000000000000 x14: 0000000000000000
```

- ✓ The Proof-of-Concept works
 - ✓ Was reproduced by the SpaceX PSIRT
- ✓ Easy to produce (undesirable) faults
 - ✓ A fully booted SoC is already being pushed to its limits
- x Slow: 1 attempt every 12 seconds (one per boot)
- x Low success rate: many hours for one good attempt
- x Unreliable: successful glitch often also results in other errors

```
288 Development login enabled: yes
289
290
291 SpaceX User Terminal.
292
293 user1 login: root
294 Password:
295
296
297
298
299
300
301 + + + + +
302 +
303 + + + + +
304 + + + + +
305 + + + + +
306 + + + + +
307 + + + + +
308 + + + + +
309 + + + + +
310
311
312 The Flight Software does not log to the console. If you wish to view
313 the output of the binaries, you can use:
314
315 tail -f /var/log/messages
316
317 Or view the viceroy telemetry stream.
318
319 <0x1b>7<0x1b>[r<0x1b>[999;999H<0x1b>[6n[root@user1 ~]# id
320 uid=0(root) gid=0(root) groups=0(root),10(wheel),1000(signers)
```

SoC Root of Trust

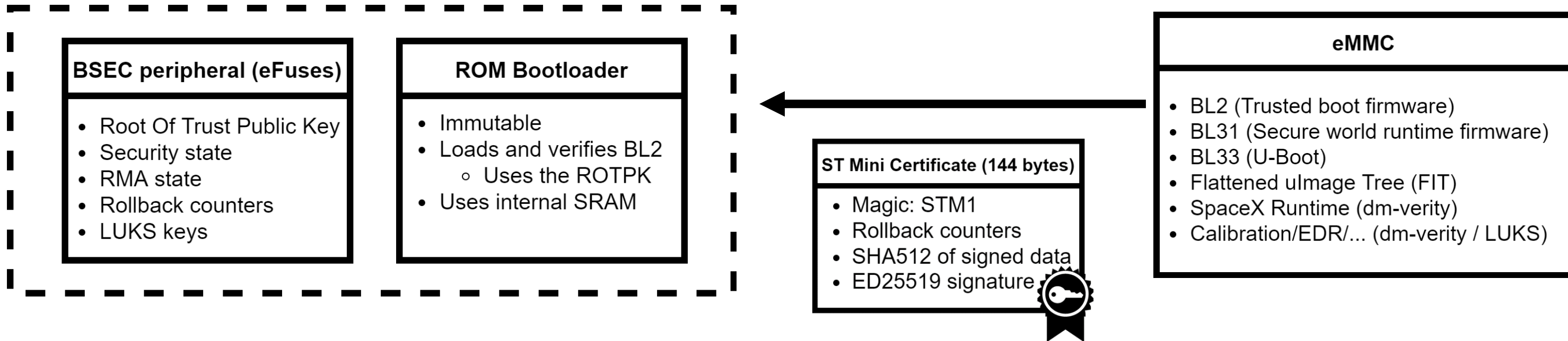

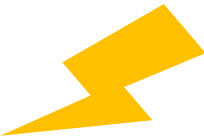
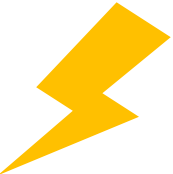
1. BL1 loads BL2 certificate from eMMC
2. BL1 verifies the certificate's signature 
3. BL1 loads the BL2 firmware from eMMC
4. BL1 verifies that SHA512(BL2) matches the hash contained in the certificate 

BL1 Glitch setup

- Try to boot with (in)valid signature, hash and firmware
- Try to glitch a valid certificate into a signature verification failure

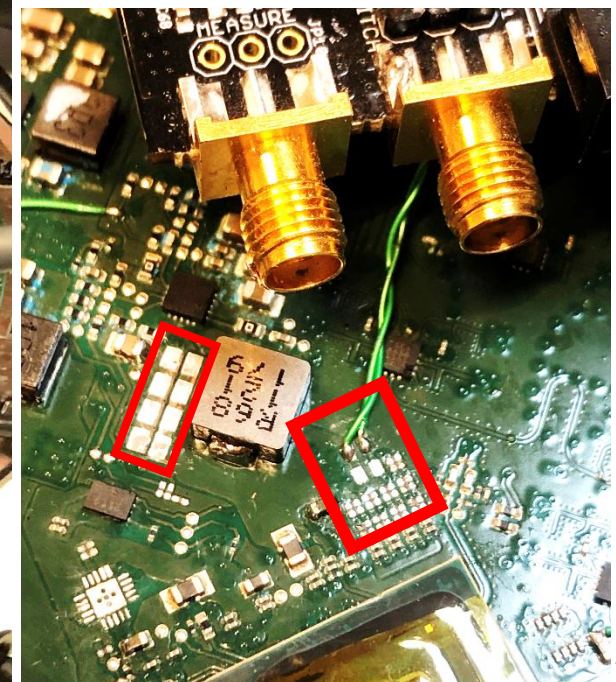
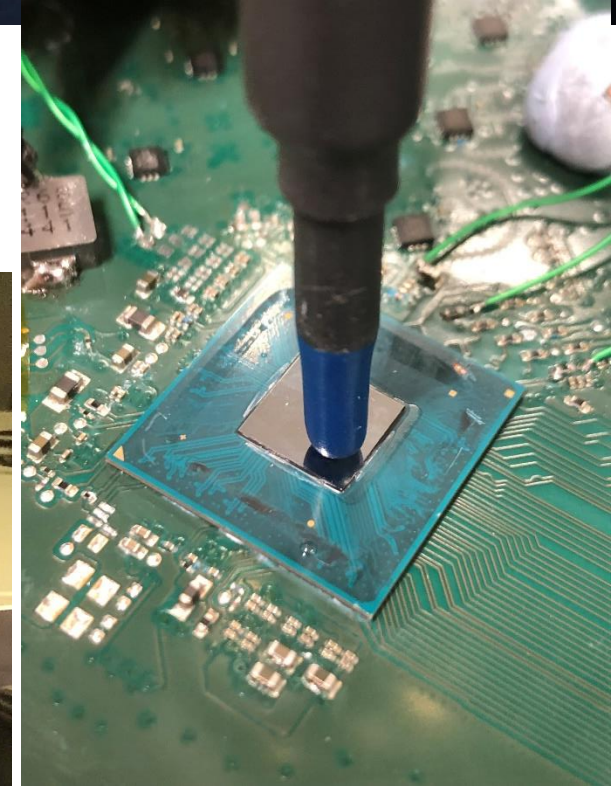
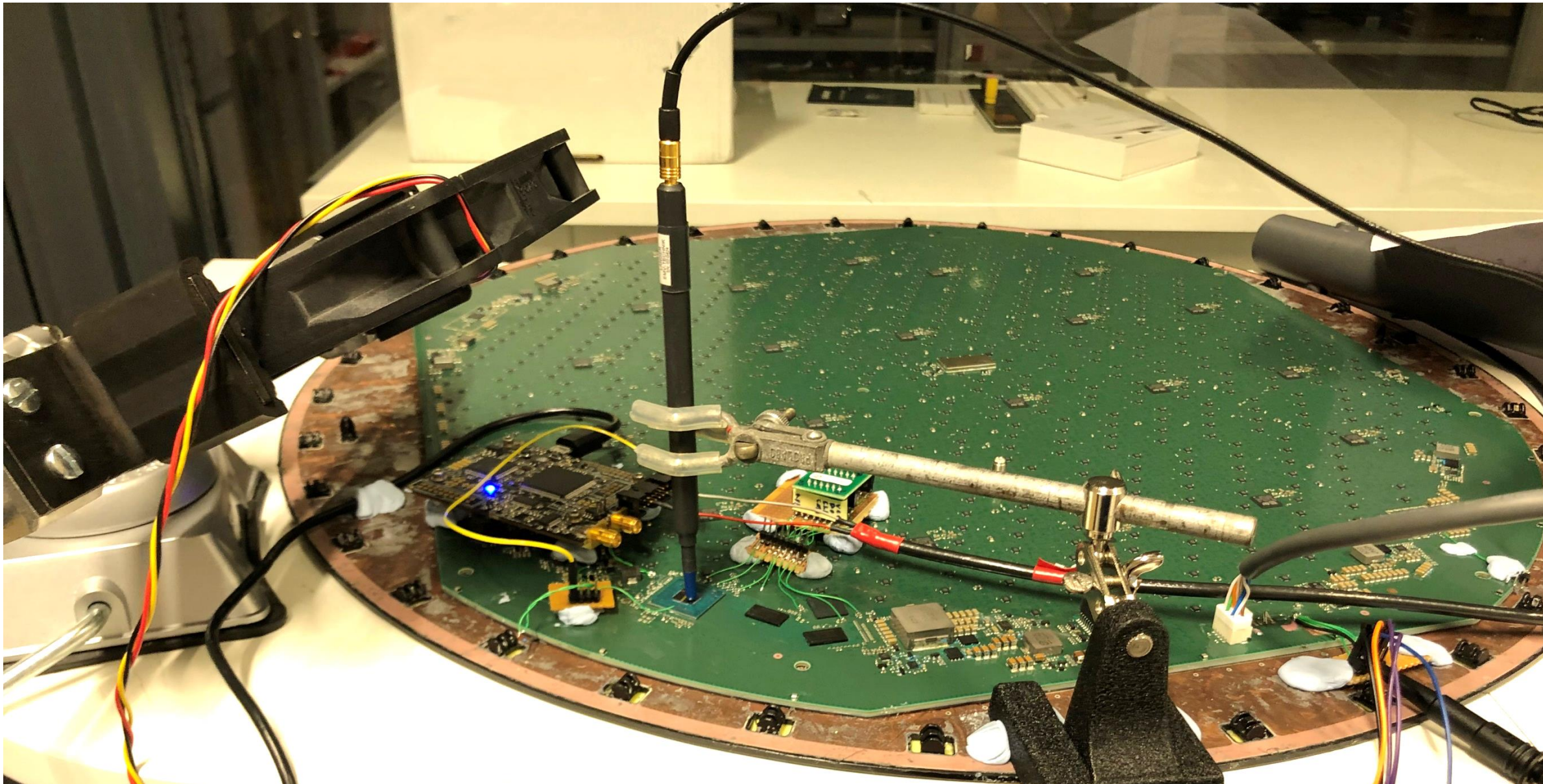

Normal boot

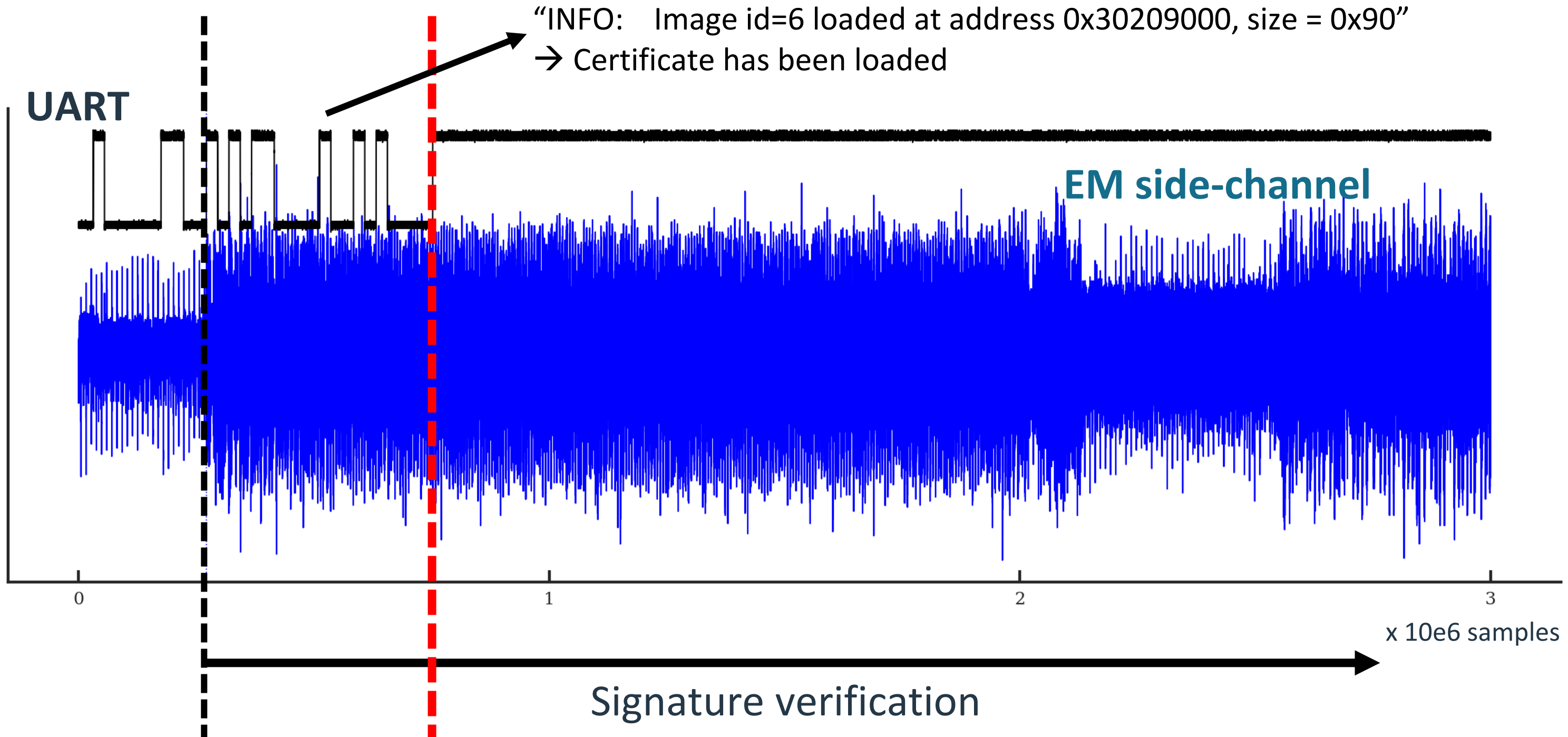

Glitched boot

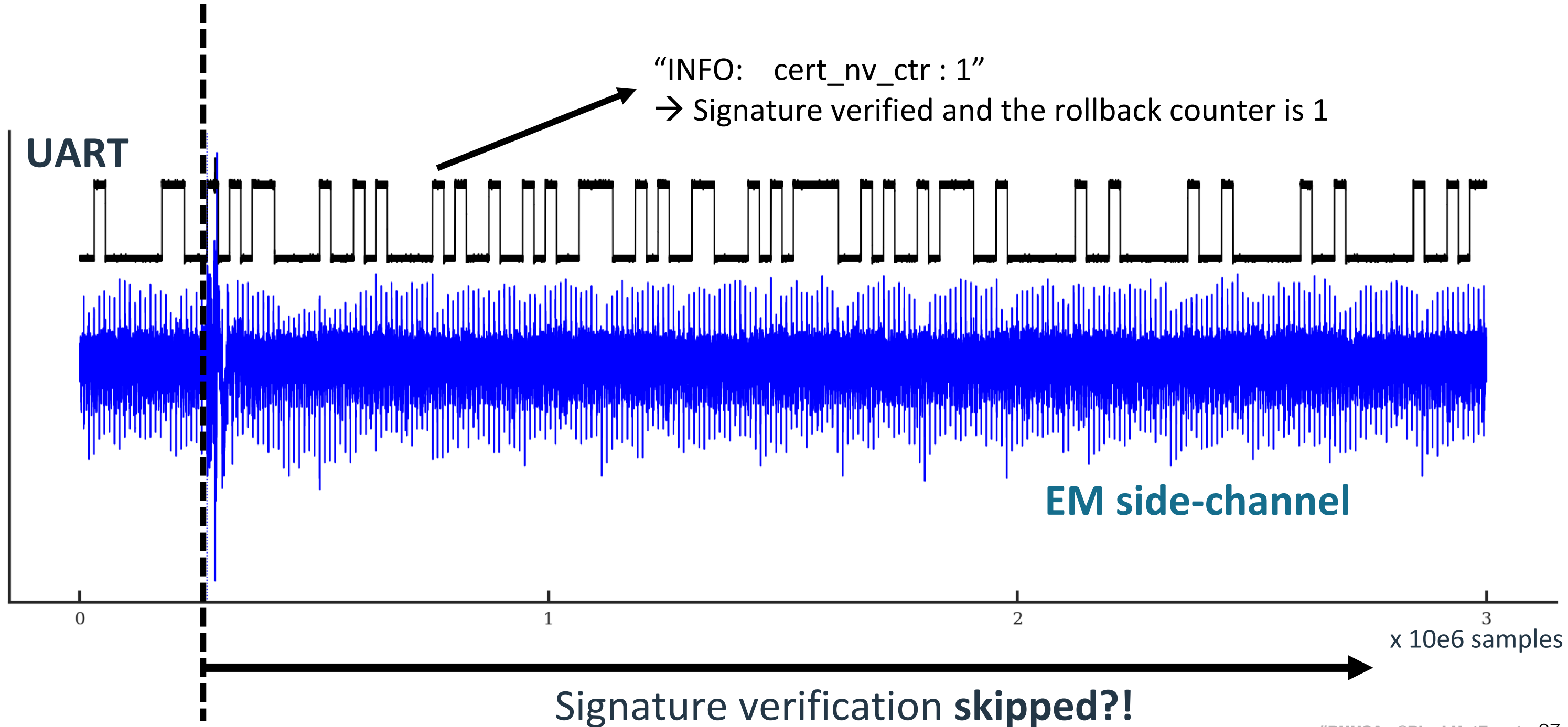

ROM Bootloader (BL1)

- Mapped at 0x30000000 and readable from BL2!
 - BSEC eFuses mapped at 0x22400000 (shadow registers)
- Emulated the ROM bootloader using Unicorn Engine
 - Fuzzed using AFL++ in Unicorn mode
- Simulated instruction skip faults in Unicorn Engine
 - Single instruction skip faults do not result in the observed behavior!
 - Code has some control flow checks and redundant operations
 - Skipping two consecutive instructions does result in the observed behavior
 - (Actual fault model is likely to be different)



github.com/unicorn-engine/unicorn



github.com/AFLplusplus/AFLplusplus

BL1 glitch detection example

BL1 UART output

```
INFO: BL1: Get the image descriptor
INFO: BL1: Loading BL2
INFO: Loading image id=6 at address 0x30209000
INFO: Skip reserving region [base = 0x30209000, size = 0x90]
INFO: Image id=6 loaded at address 0x30209000, size = 0x90

INFO: cert_nv_ctr : 1
INFO: plat_nv_ctr : 0
INFO: Loading image id=1 at address 0x30209000
INFO: Image id=1 loaded at address 0x30209000, size = 0xf178

NOTICE: BL1: Booting BL2
NOTICE: plat_error_handler err = -80
INFO: Authentication error !!!
```



Certificate has been loaded
Contains invalid signature but
valid digest of BL2 firmware

Signature verification succeeded!
Loaded BL2 firmware and
verified hash digest

Final control flow check detects
our glitch! 😞

BL1 glitch detection example

```
2 void BL1_main(void)
3
4 {
5     int iVar1;
6     int iVar2;
7     long lVar3;
8     char *__format;
9     undefined8 uVar4;
10    long unaff_x21;
11    long unaff_x22;
12
13    DAT_30200080_hash_check_val = 0x5a7cbe01;
14    DAT_30200084_signature_check_val = 0x5a7cbe01;
15    DAT_302048e4 = 0;
16    printf(s_NOTICE:BL1:_s_3000c1b8,s_v1.3(release):f26889a_3000b058);
17    printf(s_NOTICE:BL1:_s_3000c1b8,s_Built_:_13:04:48,_Jul_30_2018_3000b070);
```

①

```
2 bool verify_signature(long param_1,int param_2,long param_3,int param_4,long *param_5,int param_6,
3                       undefined8 param_7)
4
5 {
6     int iVar1;
7
8     if (((param_2 == 0x50) && (param_3 + 0x40 == param_1)) &&
9         ((param_4 == 0x40 && param_6 == 8) && *param_5 == 0x39313535324445)) {
10        DAT_30200084_signature_check_val = 0x5a7cbe01;
11        iVar1 = ed25519_verify(param_1,0x50,param_3,param_7);
12        if (iVar1 == 1) {
13            /* Signature check succeeded */
14            DAT_30200084_signature_check_val = 0xb134f725;
15        }
16        return iVar1 == 0;
17    }
18    return true;
19 }
```

②

```
2 void final_error_checking(void)
3
4 {
5     if ((DAT_30200080_hash_check_val == L'\xb134f725') &&
6         (DAT_30200084_signature_check_val == L'\xb134f725')) goto LAB_3000094c;
7     do {
8         plat_error_handler(0xffffffffb0);
9 LAB_3000094c:
10    } while (DAT_302048e4 < DAT_2240000c);
11    return;
12 }
```

③

Called right before passing control to BL2

Enabling decoupling capacitors

- Decoupling capacitors are needed for later boot stages
- Experimented with:
 - N-channel MOSFETS
 - P-channel MOSFETS
 - High/Low side switching
 - Gate voltage
 - MOSFET drivers
 - Capacitor sizes
 - Timing

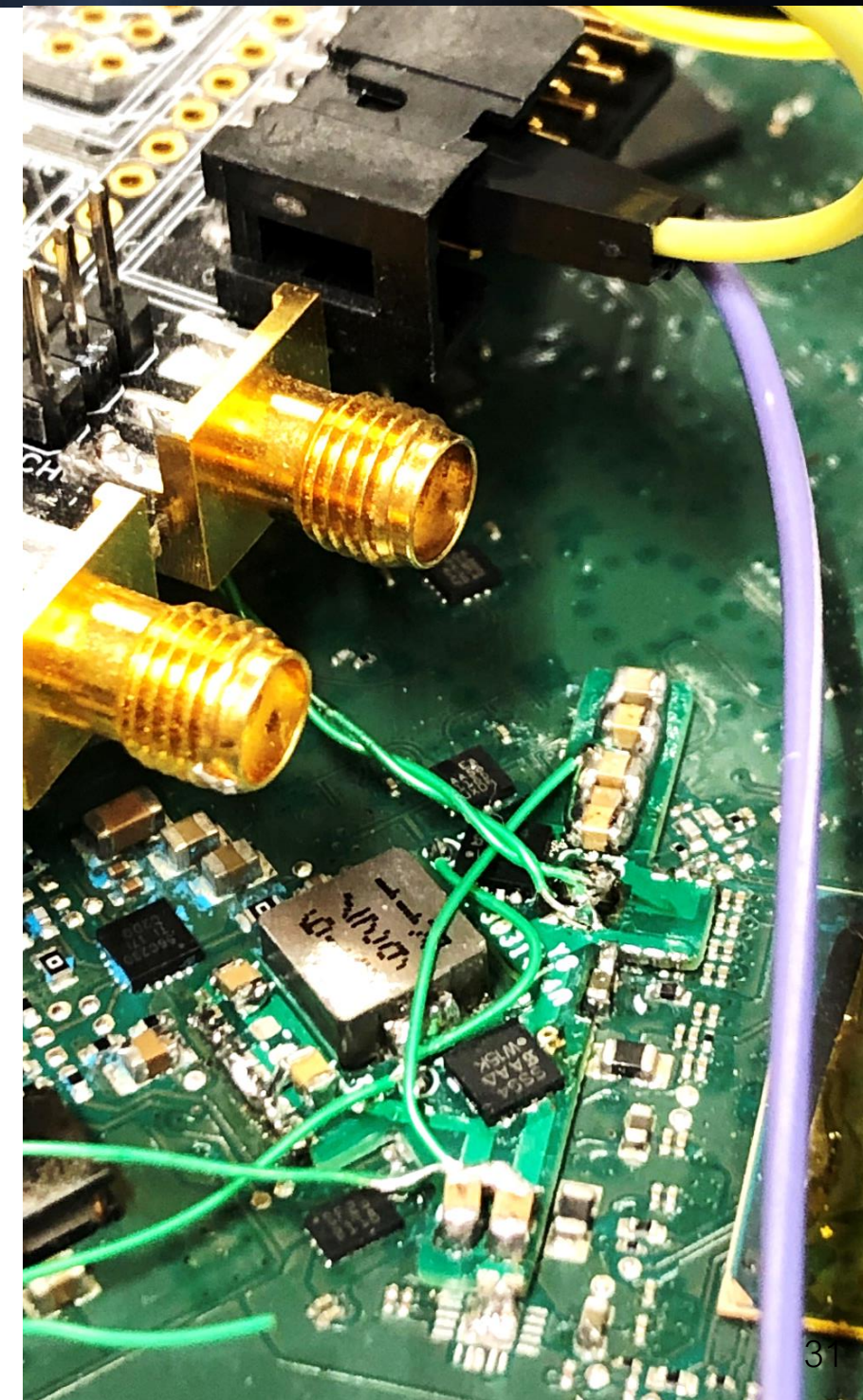

Researcher access

- Demonstrated a full attack in the lab!
 - But the setup is still too bulky to be used in a practical setting (e.g., on the roof)
- SpaceX offered an easy way out: SSH access through a Yubikey
 - But I was already too far down the rabbit hole ...

```
15 vehicle=$(whatVehicleAmI)
16 rev=$(whatRevAmI)
17 nodetype=$(whatNodeTypeAmI)
18
19 if [ "$vehicle" = "uterm" ] && [ "$rev" != "0" ]; then
20     # Create static AuthorizedPrincipalsFile for UTs and Transceivers only.
21     catson_uuid="$(printf "%08x-%08x-%08x\n" \
22         $(cat /sys/bus/platform/devices/*.catson_fuses/devid[012]))"
23
24     # Maintain compatibility with transceiver certificate format.
25     principal=$vehicle
26     if [ "$(whatVehicleVariantAmI)" = "starlink_transceiver" ]; then
27         principal="transceiver"
28     fi
29     echo "spacex:$principal:researcher:$catson_uuid" > /etc/ssh/authorized_principals
```



Creating a mobile setup

- Replacing lab equipment with low-cost off-the-shelf components
- RPI Pico replaces oscilloscope and ChipWhisperer
- Works
 - But still messy...

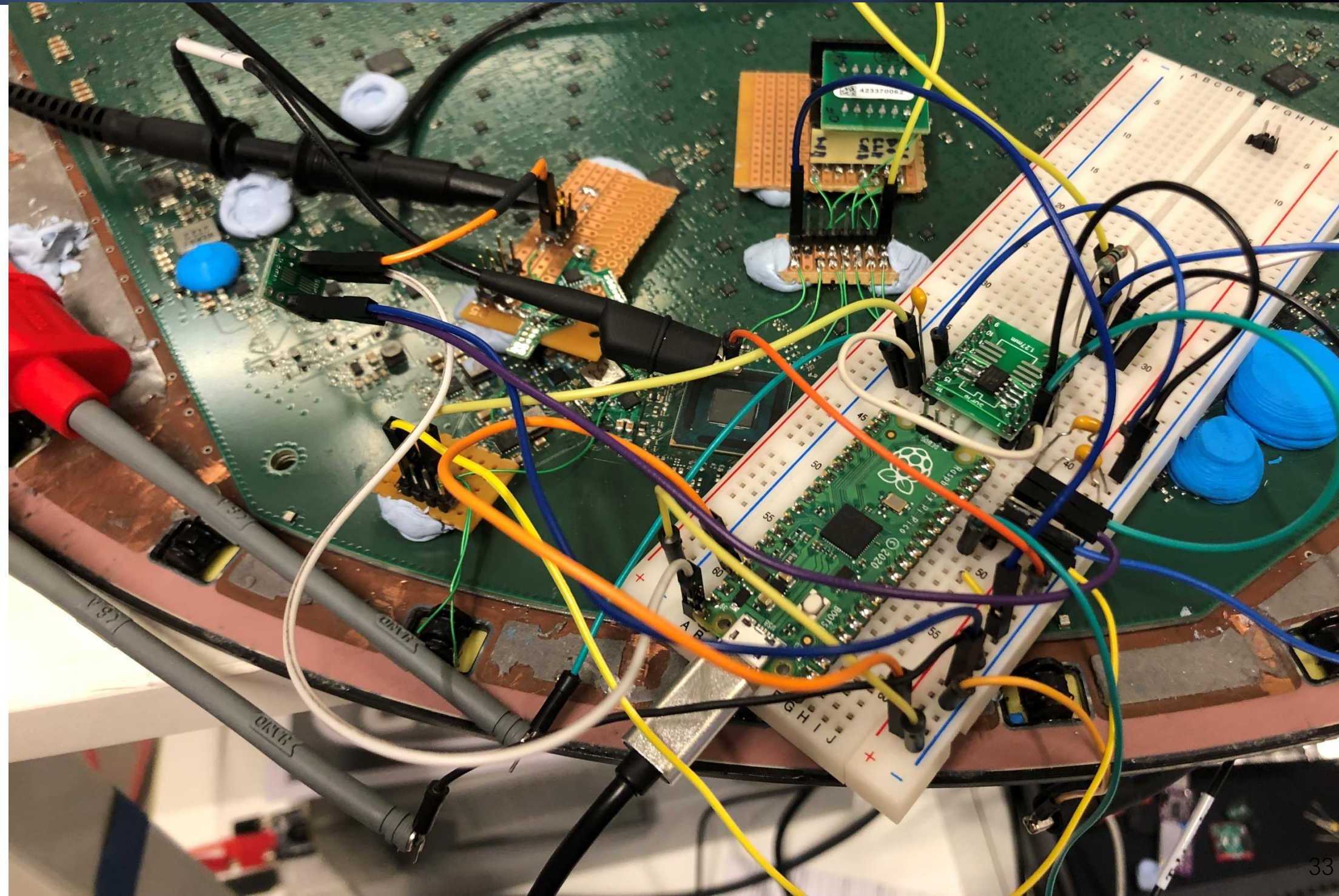

- Scanner @ 600 DPI
- Draw board outline at real size in Inkscape
 - Load in KiCad and use in the edgecuts layer

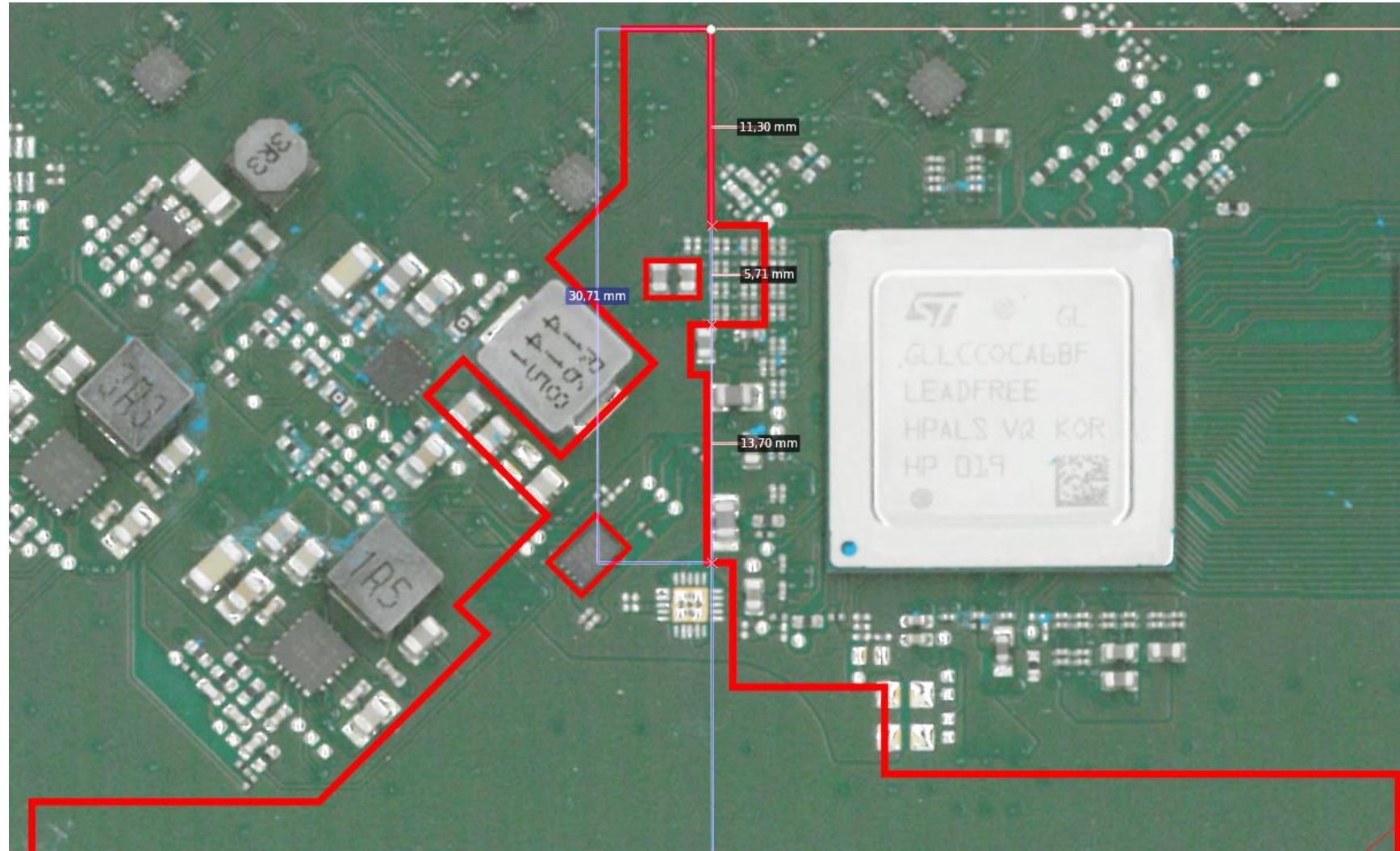

Modchip

Castellated holes to mount to the UT PCB

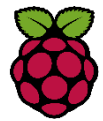

RP2040 @250MHz
PIO for triggering
and glitch generation

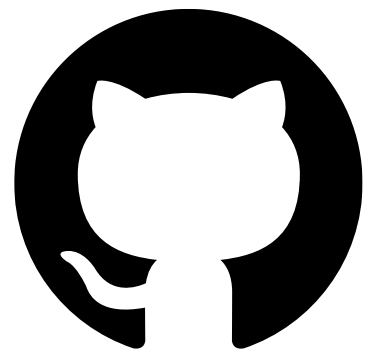

Available on GitHub!

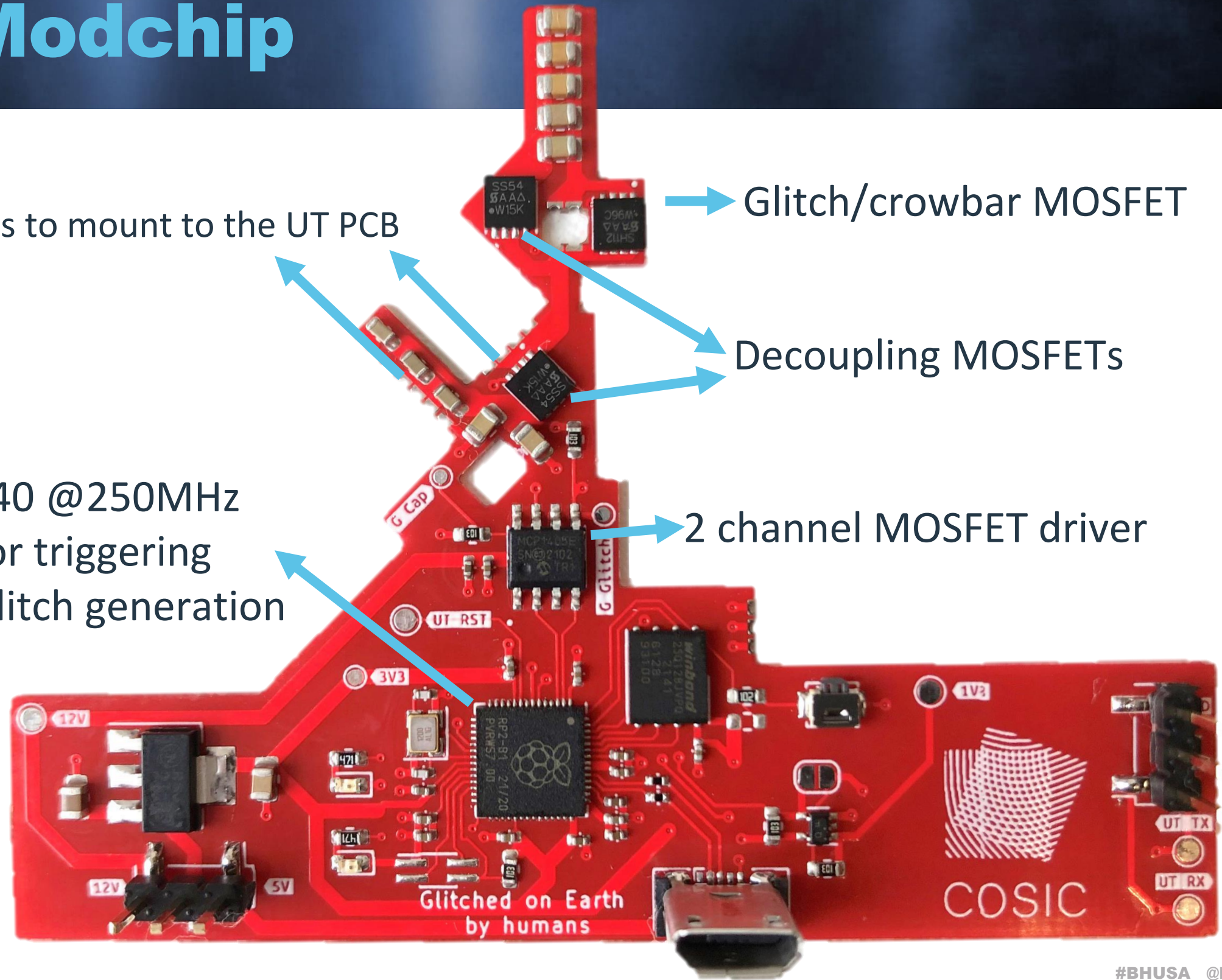

Glitch/crowbar MOSFET

Decoupling MOSFETs

2 channel MOSFET driver

6 cm
2,36"

0,8 mm

Installed modchip

Core voltage regulator
enable pin
(for power cycling)

12V for MOSFET drivers
and standalone power

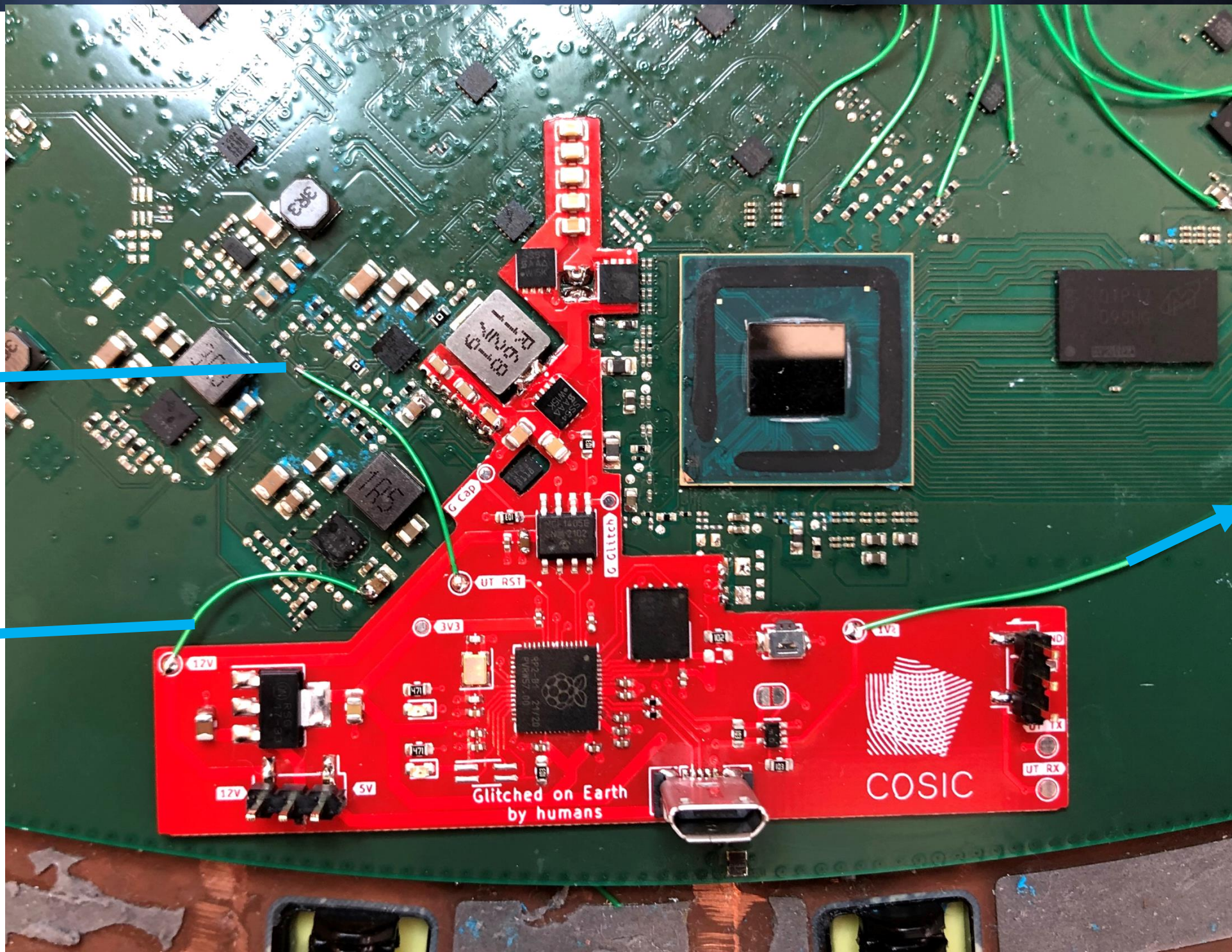

1V8 for
level shifter



SpaceX strikes back

- I did a firmware update...
- Previously unused eFuse is now blown and disables UART output
- Modchip was designed to trigger on UART

```
if (L'\xffffffff' < BSEC_UART_EN) {  
    DAT_30204160_UART_EN = L'\xde486bc3';  
}  
if (DAT_30204160_UART_EN == L'\xde486bc3') {  
    _GLLCFF_SYSCFG_PIO_A_BASE = _GLLCFF_SYSCFG_PIO_A_BASE & 0xff;  
    DataSynchronizationBarrier(3,3);  
    _GLLCFF_SYSCFG_PIO_A_BASE_A0 = _GLLCFF_SYSCFG_PIO_A_BASE_A0 & 0xff;  
    DataSynchronizationBarrier(3,3);  
    uVar1 = 10000000;  
    if ((_BOOTMODE_REGISTER_09130048 & 1) != 0) {  
        uVar1 = 200000000;  
    }  
    set_uart_baud(&UART_BAUDRATE,uVar1,115200);  
    printf(s_INFO:_AUTOSTARTUP_MODE_=_%d_3000b08e,(ulong)(_BOOTMODE_REGISTER_09130048 & 1));  
}
```



Adapt

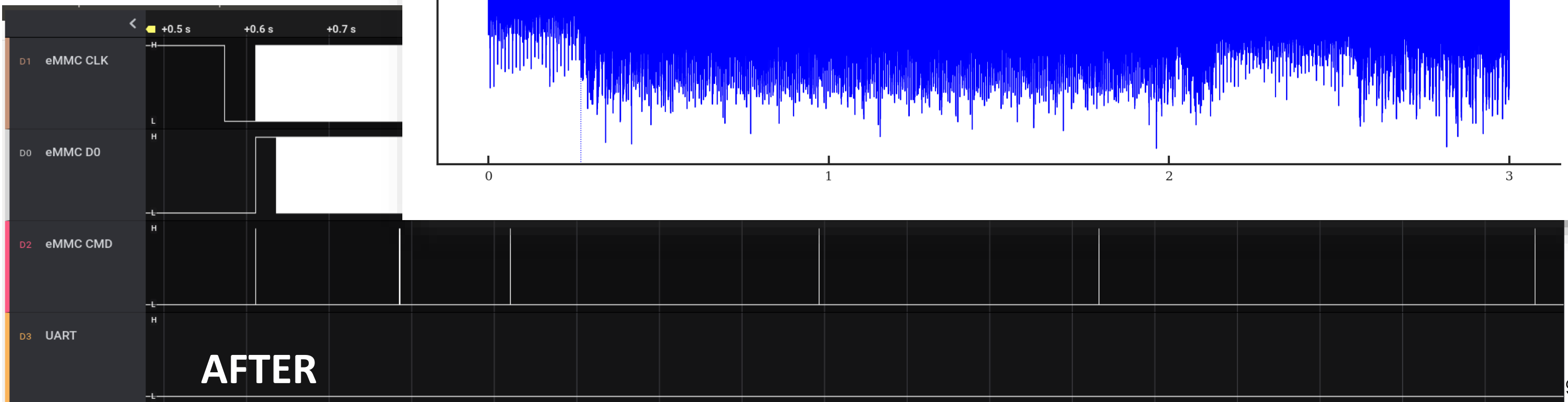
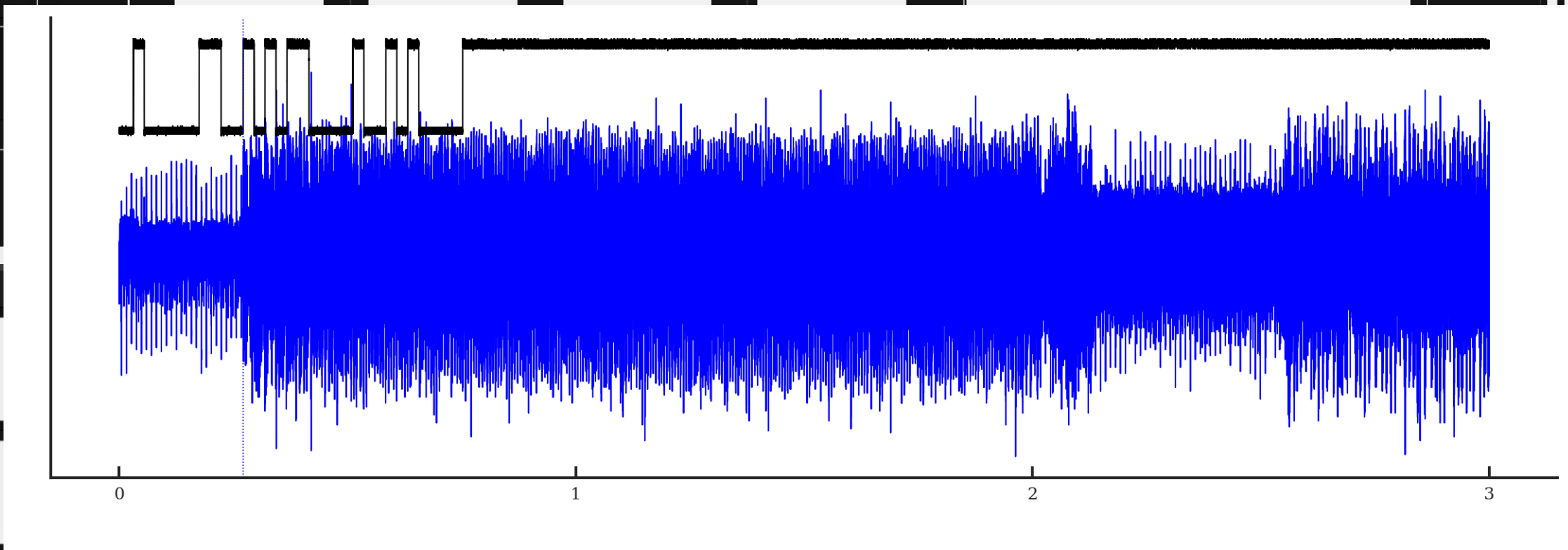
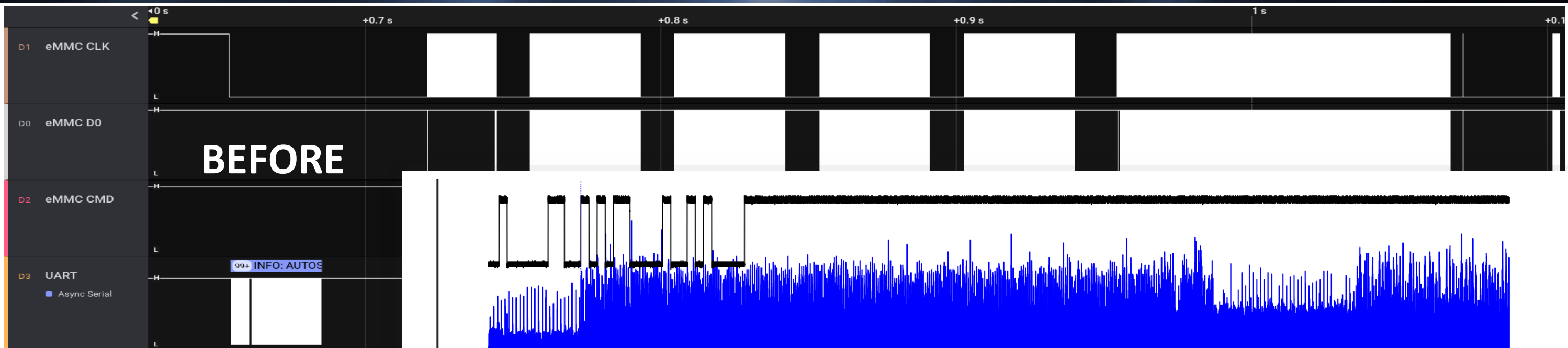

- Trigger on eMMC D0 instead of UART
- Modchip could be easily adapted
 - Disconnect UT UART TX
 - Connect to eMMC D0
 - Update glitch parameters from Python
- Alternative: new PCB revision

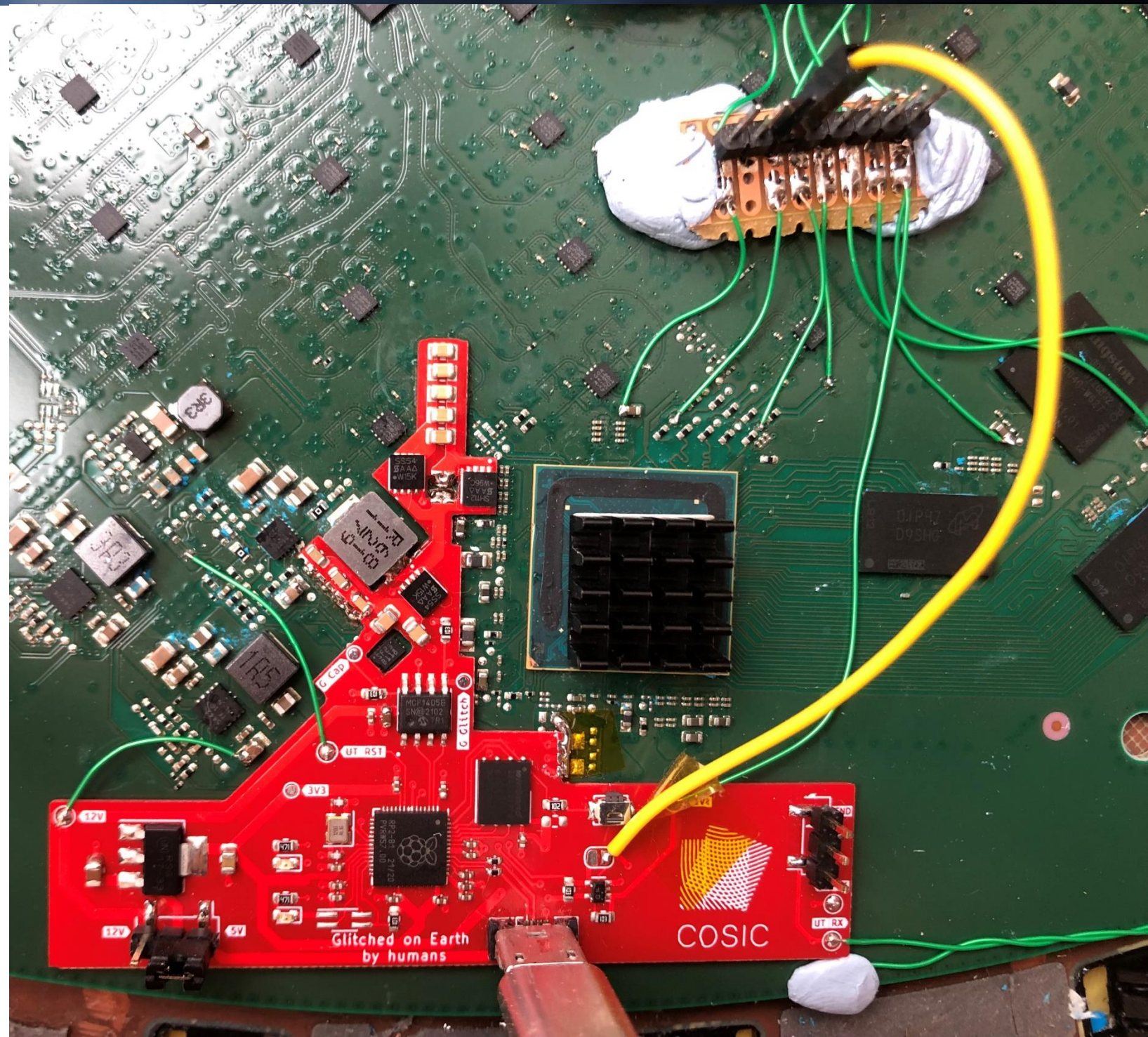

- All interesting communication uses mutually authenticated TLS (STSAFE)
- Added STSAFE support to the tslite-ng TLS implementation
 - Python script to download the latest firmware updates
- Mostly IPv6 2620:134:b000::1:0:0
 - Open ports (nmap): 8001-8012, 9000, 9003, 9005, 9010, 9011

Firmware update archive

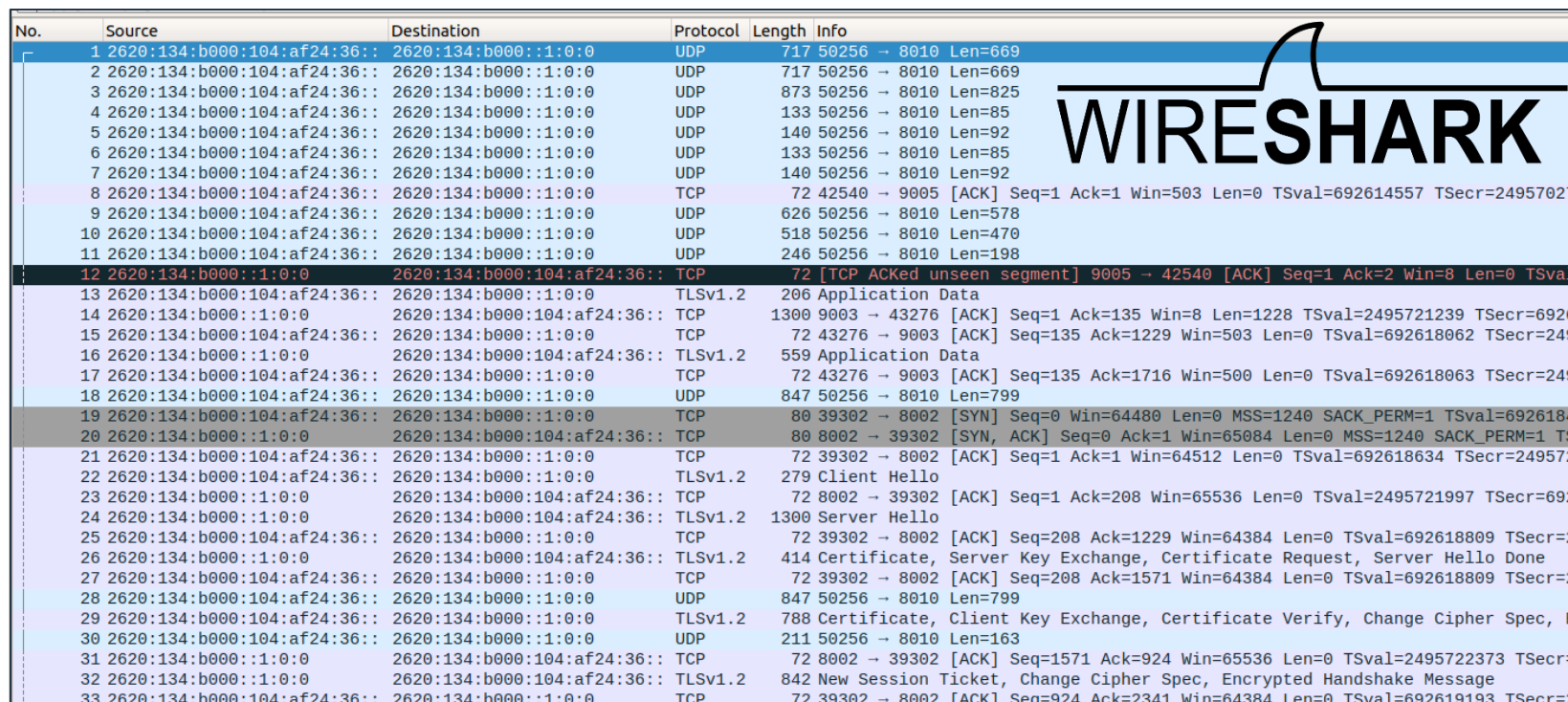

No.	Source	Destination	Protocol	Length	Info
1	2620:134:b000:104:af24:36::1:0:0	2620:134:b000::1:0:0	UDP	717	50256 → 8010 Len=669
2	2620:134:b000:104:af24:36::1:0:0	2620:134:b000::1:0:0	UDP	717	50256 → 8010 Len=669
3	2620:134:b000:104:af24:36::1:0:0	2620:134:b000::1:0:0	UDP	873	50256 → 8010 Len=825
4	2620:134:b000:104:af24:36::1:0:0	2620:134:b000::1:0:0	UDP	133	50256 → 8010 Len=85
5	2620:134:b000:104:af24:36::1:0:0	2620:134:b000::1:0:0	UDP	140	50256 → 8010 Len=92
6	2620:134:b000:104:af24:36::1:0:0	2620:134:b000::1:0:0	UDP	133	50256 → 8010 Len=85
7	2620:134:b000:104:af24:36::1:0:0	2620:134:b000::1:0:0	UDP	140	50256 → 8010 Len=92
8	2620:134:b000:104:af24:36::1:0:0	2620:134:b000::1:0:0	TCP	72	42540 → 9005 [ACK] Seq=1 Ack=1 Win=503 Len=0 TSval=692614557 TSecr=24957027
9	2620:134:b000:104:af24:36::1:0:0	2620:134:b000::1:0:0	UDP	626	50256 → 8010 Len=578
10	2620:134:b000:104:af24:36::1:0:0	2620:134:b000::1:0:0	UDP	518	50256 → 8010 Len=470
11	2620:134:b000:104:af24:36::1:0:0	2620:134:b000::1:0:0	UDP	246	50256 → 8010 Len=198
12	2620:134:b000::1:0:0	2620:134:b000:104:af24:36::1:0:0	TCP	72	[TCP ACKed unseen segment] 9005 → 42540 [ACK] Seq=1 Ack=2 Win=8 Len=0 TSval=692614557 TSecr=24957027
13	2620:134:b000:104:af24:36::1:0:0	2620:134:b000::1:0:0	TLSv1.2	206	Application Data
14	2620:134:b000::1:0:0	2620:134:b000:104:af24:36::1:0:0	TCP	1300	9003 → 43276 [ACK] Seq=1 Ack=135 Win=8 Len=1228 TSval=2495721239 TSecr=692614557
15	2620:134:b000:104:af24:36::1:0:0	2620:134:b000::1:0:0	TCP	72	43276 → 9003 [ACK] Seq=135 Ack=1229 Win=503 Len=0 TSval=692618062 TSecr=2495721239
16	2620:134:b000::1:0:0	2620:134:b000:104:af24:36::1:0:0	TLSv1.2	559	Application Data
17	2620:134:b000:104:af24:36::1:0:0	2620:134:b000::1:0:0	TCP	72	43276 → 9003 [ACK] Seq=135 Ack=1716 Win=500 Len=0 TSval=692618063 TSecr=2495721239
18	2620:134:b000:104:af24:36::1:0:0	2620:134:b000::1:0:0	UDP	847	50256 → 8010 Len=799
19	2620:134:b000:104:af24:36::1:0:0	2620:134:b000::1:0:0	TCP	80	39302 → 8002 [SYN] Seq=0 Win=64480 Len=0 MSS=1240 SACK_PERM=1 TSval=6926184 TSecr=2495721239
20	2620:134:b000::1:0:0	2620:134:b000:104:af24:36::1:0:0	TCP	80	8002 → 39302 [SYN, ACK] Seq=0 Ack=1 Win=65084 Len=0 MSS=1240 SACK_PERM=1 TSval=6926184 TSecr=2495721239
21	2620:134:b000:104:af24:36::1:0:0	2620:134:b000::1:0:0	TCP	72	39302 → 8002 [ACK] Seq=1 Ack=1 Win=64512 Len=0 TSval=692618634 TSecr=2495721239
22	2620:134:b000:104:af24:36::1:0:0	2620:134:b000::1:0:0	TLSv1.2	279	Client Hello
23	2620:134:b000::1:0:0	2620:134:b000:104:af24:36::1:0:0	TCP	72	8002 → 39302 [ACK] Seq=1 Ack=208 Win=65536 Len=0 TSval=2495721997 TSecr=692618634
24	2620:134:b000::1:0:0	2620:134:b000:104:af24:36::1:0:0	TLSv1.2	1300	Server Hello
25	2620:134:b000:104:af24:36::1:0:0	2620:134:b000::1:0:0	TCP	72	39302 → 8002 [ACK] Seq=208 Ack=1229 Win=64384 Len=0 TSval=692618809 TSecr=2495721997
26	2620:134:b000::1:0:0	2620:134:b000:104:af24:36::1:0:0	TLSv1.2	414	Certificate, Server Key Exchange, Certificate Request, Server Hello Done
27	2620:134:b000:104:af24:36::1:0:0	2620:134:b000::1:0:0	TCP	72	39302 → 8002 [ACK] Seq=208 Ack=1571 Win=64384 Len=0 TSval=692618809 TSecr=2495721997
28	2620:134:b000:104:af24:36::1:0:0	2620:134:b000::1:0:0	UDP	847	50256 → 8010 Len=799
29	2620:134:b000:104:af24:36::1:0:0	2620:134:b000::1:0:0	TLSv1.2	788	Certificate, Client Key Exchange, Certificate Verify, Change Cipher Spec, Encrypted Handshake Message
30	2620:134:b000:104:af24:36::1:0:0	2620:134:b000::1:0:0	UDP	211	50256 → 8010 Len=163
31	2620:134:b000::1:0:0	2620:134:b000:104:af24:36::1:0:0	TCP	72	8002 → 39302 [ACK] Seq=1571 Ack=924 Win=65536 Len=0 TSval=2495722373 TSecr=692618809
32	2620:134:b000::1:0:0	2620:134:b000:104:af24:36::1:0:0	TLSv1.2	842	New Session Ticket, Change Cipher Spec, Encrypted Handshake Message
33	2620:134:b000:104:af24:36::1:0:0	2620:134:b000::1:0:0	TCP	72	39302 → 8002 [ACK] Seq=924 Ack=2341 Win=64384 Len=0 TSval=692619193 TSecr=2495722373

Name	Size
0ad30efd-5511-48bd-86e6-a9a5bd9c4140.uterm.release	34,3 MB
0ff779fe-a697-4464-8fe4-e05d4aa51754.uterm.release	36,0 MB
6e4bc82a-9fa9-442d-8be0-92ef529514e7.uterm.release	33,9 MB
7e10fc86-eb96-4b86-a0d4-95a45017944d.uterm.release	36,0 MB
169171df-70e1-4858-9d6f-9ba0885891a1.uterm.release	36,3 MB
29424243-0ba5-4e9b-b402-79d25cb6f8de.uterm.release	50,3 MB
a6b08c6e-3b2d-4346-af31-a54397819878.uterm.release	35,7 MB
b9b5b228-5d06-4bd5-999f-8f278d8022d4.uterm.release	50,3 MB
c06c67d2-401c-4d6a-9bd2-25af7370392b.uterm.release	33,1 MB
c9ae03c7-e90a-4f61-87e8-fb484272f30b.uterm.release	35,9 MB
cd5f774c-1c0e-4da8-9411-e7538713f511.uterm.release	36,3 MB
de06deab-2814-4496-9ad7-bd47cc9e6ecc.uterm.release	35,9 MB
ffbba606-958e-40c1-9668-b8f1cbf13081.uterm.release	50,3 MB

What's next?

- You can make your own modchip and use it to:
 - Further explore the network infrastructure
 - Not accessible as a normal user
 - Integrate the STSAFE with GRPC
 - Interact with the Digital BeamFormers and update their firmware
 - Repurpose your terminal?

```
[root@user1 bin]# ./ut_silicon_diag --dbf=1 --write_csv=false
FSW peek/poke client created successfully.
Clearing Shiraz RFFE FIFO Status register.
2.
Functional read: 2.3.4.5.6.7.8.9.10.11.12.13.14.15.16.17.18.19.20.21.22.23.2
2.
Engineering read: 2.3.4.5.6.7.8.9.10.11.12.13.14.15.16.17.18.19.20.21.22.23.2
2.
2.
dbf_id,fem_id,func_reg_0F_00,eng_reg_0F_00
1,2,0x3B1C1B00C21AC3980E04AA401026414D,0x0000C4D91C25539B00621654970B3400
1,3,0xBB1A1800C21AC3980F059A040425C56D,0x8000D70A1D246099006214C945190AAD
1,4,0x36181800C21AC3980E04ACC02416416D,0x000025E91C21509900621654970C1788
1.5.0xBA1A1A00C21AC3980E0599041226C96D.0x8000D4EB1C23529A006214C94515B1B0
```

Conclusion

- We can bypass secure boot using voltage fault injection in BL1
 - Quad core Cortex-A53 in a black box scenario
 - no documentation, no open development kits
 - Enabling and disabling of decoupling capacitors
 - Fault injection countermeasures are only as good as the fault model that was used
- This is a well-designed product (from a security standpoint)
 - No obvious (to me) low-hanging fruit
 - In contrast to many other devices getting a root shell was challenging
 - And a root shell does not immediately lead to an attack that scales
- SpaceX PSIRT was very responsive and helpful!
 - <https://bugcrowd.com/spacex> vulnerabilityreporting@spacex.com



COSIC



github.com/KULeuven-COSIC/Starlink-FI



lennert.wouters@esat.kuleuven.be



[@LennertWo](https://twitter.com/LennertWo)

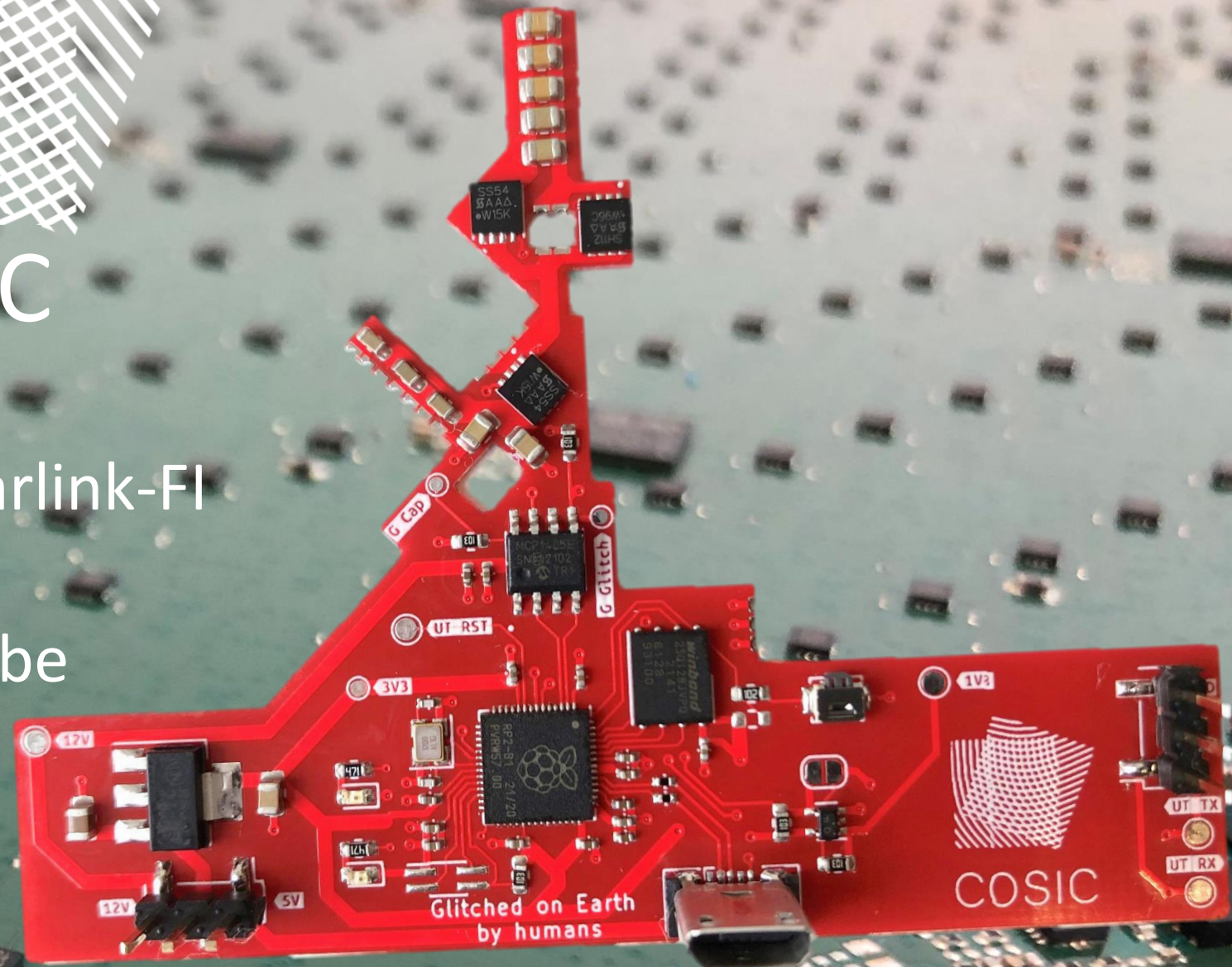

MADE ON EARTH BY HUMANS

```
> python3.10 utglitcher.py
```



```
INFO - Established serial connection
INFO - Connected to modchip
Press enter to start.
INFO - Attempting to bypass secure boot...
58it [00:58, 1.00s/it]
INFO - Glitch successul!
>
```

```
NOTICE: BL20: Built : 16:55:25, Jul 17 2020
NOTICE: EMMC boot counter is 651
NOTICE: BL2: Patched on Earth!
NOTICE: BL2: Built : 01:17:09, Feb 5 2022
NOTICE: Evaluate 0x8102010 & 0xf == 0x4 -> 0
NOTICE: Evaluate 0x8102010 & 0xf == 0x8 -> 0
NOTICE: Evaluate 0x8102010 & 0xf == 0xc -> 0
NOTICE: Evaluate 0x8102010 & 0xf == 0x5 -> 1
NOTICE: Using alternate targetpack config index 3
NOTICE: BL2: end TP
NOTICE: BL31: Patched on Earth!
NOTICE: BL31: Built : 01:17:09, Feb 5 2022
```

```
U-Boot 2021.04-g84e5f81 (Feb 05 2022 - 01:17:09 +0000)
```

```
Model: Catson
DRAM: 1004 MiB
MMC: Fast boot:eMMC: 8xbit - div2
stm-sdhci0: 0
In: serial
Out: serial
Err: serial
CPU ID: 0x00020a01 0x868dc3eb 0x8332b785
sdhci_set_clock: Timeout to wait cmd & data inhibit
No SXID found
Detected Board rev: #rev2_proto4
FIP1: 3 FIP2: 3
BOOT SLOT B
Net: Net Initialization Skipped
No ethernet found.
```

Demo!

Thanks!

- Arthur Beckers
- Gert Van Beneden
- Tim Ferrell
- John McMaster
- Dan Murray
- Colin O'Flynn